

Pioneer[®]
ATHLETICS

SMALL TOWNS TO BIG CITIES

YOUTH LEAGUES TO PRO TEAMS

celebrate your field

ingredients matter.

®

Phone 800-877-1500

Fax 800-877-1511

www.pioneerathletics.com

Pioneer Athletics New Products



PleeFix™
Ground Markers

PleeFix™ Ground Markers Now in Green

Pg. 12

GameDay®
Wheel-to-Wheel

Pg. 7



Soccer Foam Spray

Pg. 39

P-REX

Pg. 17



Blitz™ HT
(High Temperature)

Pg. 15



Sweat X™ Laundry

Pg. 47



GAMELINE®
SUBZERO

GameLine®
Subzero

Pg. 14



GAMELINE®
CLEAR

GameLine®
Clear

Pg. 14



Titan®
Extreme

Pg. 16



Crewzer
Junior

Pg. 18



Wheel-to-Wheel
Line Painter

Pg. 39

What's our game plan?

We're in business to reduce or eliminate frustrations associated with athletic field painting and maintenance. Our sole focus is on your fields, and producing a full set of highly specialized products that improve your satisfaction.

Customers, new technologies, product innovation and environmental awareness all fuel our commitment to deliver the highest quality products in the industry.

Pioneer is proud to have been recognized as a researcher, developer and producer of industry-leading paint formulas for just about any sport, occasion or special event you can hold on synthetic turf and natural grass fields. We match those products with a commitment to a deep and broad array of field marking equipment, stencils, custom logos, maintenance equipment, athletic accessories and antimicrobial coatings.

In everything we do, the ingredients used to formulate our products will be chosen specifically to accommodate the needs, requirements, and well-being of our customers.

It all boils down to this: It's your job to make your field, facility and team look and operate like a champion, and it's our job to help you get there.

You'll find the tools you need right here within the pages of this catalog.

SportsTurf
MANAGERS ASSOCIATION



Table of Contents

| | | | |
|--|--------------|--|--------------|
| ■ Natural Grass | 2-13 | ■ Football Accessories | 34-37 |
| Pioneer Ultra-Friendly Paints | 2-5 | Markers and Down Indicators | 34 |
| Natural Grass Bulk Paints | 6-7 | Goal Post Pads, Paint & Streamers | 35 |
| Turf Colorant | 8 | Field Goals and Netting Systems | 36 |
| Field Marking Paint Accessories | 9 | Track Protectors & Sideline Tarps | 37 |
| Aerosol Field Marking Paint & Stripers | 10-11 | | |
| Field Painting Layout Tools | 12 | ■ Soccer Accessories | 38-41 |
| Grounds Maintenance | 13 | Shelters, Anchors & Corner Flags | 38 |
| | | Paint and Goals | 39 |
| ■ Synthetic Turf | 14-19 | Soccer Goals Continued | 40 |
| Synthetic Turf Field Marking Paint | 14-16 | Nets, Fasteners, Clips & Pegs | 41 |
| Synthetic Turf Maintenance Equipment | 17-18 | | |
| Synthetic Turf Accessories | 19 | ■ Facilities | 38-41 |
| | | Benches & Bleachers | 42-43 |
| ■ Striping Machines | 20-23 | Windscreens | 44 |
| Airless Field Marking Machines | 20-21 | Protective Padding | 45 |
| Low Pressure Field Marking Machines | 22-23 | Wrestling Accessories | 46 |
| | | Antimicrobials, Disinfectants & Cleaning | 47 |
| ■ Stencils | 24-25 | Tennis Court Accessories | 48 |
| Custom Stencils | 24 | Parking Lot Maintenance & Weed Control | 49 |
| Standard Stencils | 25 | | |
| | | ■ Field Layout Diagrams | 50-56 |
| ■ Baseball Accessories | 26-33 | | |
| Infield Covers and Mats | 26 | | |
| Chalk and Chalk Liners | 27 | | |
| Baseball Bases | 28-29 | | |
| Baseball Field Maintenance | 30-32 | | |
| Baseball Fencing and Padding | 33 | | |

ingredients matter.®

www.pioneerathletics.com

1-800-877-1500

Just Got Ultra-Colorful.

The World's First Line of VOC-Free, EPA-Recognized Paints* Now Include Brighter, Longer-Lasting Colors.

Nearly eight years after the first lab work began on creating environmentally-friendly paints, your opportunity to get colorful is here. The Ultra-Friendly line of field paints now expands to six colors to give users colorful options for the first time in the industry's history.



Recognized for safer chemistry.
www.epa.gov/dfe

Get Great Paint and Greener, Cleaner Fields

Ultra-Friendly White and Blue are EPA-Recognized. Black, red, yellow and orange are pending. All six colors follow Pioneer's strict principles of tracing every ingredient to its source and assuring environmental sensitivity that takes better care of fields, the people who care for them and the people who play on them.

Hear it Straight from Our Customers. →



"We used Brite Stripe Ultra-Friendly the other day on our fields. I was impressed by how much brighter it was when we applied it. But I was really impressed by how much longer it lasted."

"Normally we have to touch-up the fields after playing 4 games over a 2-day period here in the desert sun, but we were able to play 6 games over 3 days and the field still looked good enough for competition."

George Schadegg
 Sports Specialist
 Special Projects and Construction

Marine Corps Air Ground Combat Center
 Twentynine Palms, CA

"Great news! I just met with the south campus grounds crew. They are striping football fields today with the new Ultra-Friendly paint and the crew likes that the paint is nice and bright!"



Raul Bueno

San Jose State University
 San Jose, CA

"We are always looking for more environmentally conscious ways of doing things. A paint with zero VOC's made our decision easy."

"With the brightest lines and less frequent painting, Brite Stripe Ultra-Friendly saves us time and money."

Peter Thibeault, CSFM

Director of Buildings and Grounds
 Special Projects and Construction

Noble and Greenough School
 Dedham, MA



*Ultra-Friendly White and Blue are currently DFE-recognized paints by the EPA. Ultra-Friendly Red, Orange, Yellow, and Black are pending EPA approval for DFE recognition.

Pioneer Ultra-Friendly Paints

Brighter, "greener", better-performing paints. Now available in a variety of environmentally-friendly colors.



Environmental Excellence Has a Brighter, Higher Standard

Get outstanding results without environmental compromise. On top of the brightness and durability you expect from Pioneer paints, our Ultra-Friendly line adds all-new proprietary formulations that combine to leave users satisfied and the fields they manage greener than ever.

The World's First Line of VOC-Free, EPA Recognized Field Marking Paints

Ultra-Friendly proves that the grass can be greener. They are the turf industry's first VOC-free paints, and only to receive EPA recognition. Ultra-Friendly's "Design for the Environment" rating comes as the result of a pioneering partnership with the Environmental Protection Agency to formulate products with environmentally preferable chemistry. It's a dedication you'll appreciate on the field and off.

In Everything We Do, ingredients matter.

So much goes into effectively managing a great athletic surface. That's why every Pioneer product is engineered from the ground up to ensure that only the right ingredients are included. The individual components and qualities of every paint, striper, groomer, stencil and antimicrobial agent play into your results. Whether your task is to mark a field for a year or just one event, count on Pioneer to provide the right components that make it one of your best looking and least difficult jobs yet.



See Page 4-5 for Details on Our Line of Ultra-Friendly Field Marking Paints.

Development lab work begins. Initial contact made with Environmental Protection Agency (EPA) concerning the Design for the Environment (DfE) program.



Brite Stripe® Ultra-Friendly submitted to the EPA for DfE consideration.

Pioneer contracts with and submits data to an EPA affiliated laboratory.

Pioneer writes white paper to detail the state of the industry for the EPA.

Dr. Grady Miller, professor and turf grass specialist at North Carolina State University (NCSSU), submits study to the EPA DfE program.

Brite Stripe® Ultra-Friendly receives DfE recognition.



Pioneer launches program to create new pigmentation systems that are zero VOC and extremely environmentally friendly.

GameDay® and StarLine® UF submissions made to the EPA DfE program.



GameDay® and StarLine® UF recognized by the EPA DfE program.

Ultra-Friendly's blue pigment is approved by the EPA

→ Our Ultra-Friendly Future...

Environmentally-Friendly Field Paints

Zero-VOC's. Zero compromise. Brighter, "greener", better-performing field marking paints.



Brite Stripe® Ultra-Friendly

Over 2,500 customers agree... Brite Stripe Ultra-Friendly is Brighter, Whiter and Longer-Lasting.

Only Pioneer makes VOC-Free, EPA recognized field marking paints for the turf industry.

- Ultra-Friendly to the environment
- The world's first Zero-VOC (Volatile Organic Compounds) field marking paint.

WHITE - ATHUFW5, BLUE - ATHUFB5, RED - ATHUFR5,
 ORANGE - ATHUFO5, YELLOW - ATHUFY5,
 BLACK - ATHUFBK5, PURPLE -ATHUFP, PINK - ATHUFPK



GameDay® Ultra-Friendly

When your game is on the line.® GameDay's premium performance fits perfectly with major events.

- For championships, playoffs, special events and other nationally televised occasions
- Mixed with a higher concentration of premium pigment and optical brighteners than other natural grass marking paint
- For eye-pleasing optic whites and fan-stunning custom color matches that create pride in your facility

WHITE - GDUFW5, BLUE - GDUFB5, RED - GDUFR5,
 ORANGE - GDUFO5, YELLOW - GDUFY5, BLACK - GDUFBLK5,
 PURPLE - GDUFPP, PINK - GDUFPPK



StarLine™

Quality, ease and performance. VOC-free field marking paint designed for the StarLiner™ electric field striping machine.

- The StarLine Ultra-Friendly field lining system is the easy, affordable, green way to produce crisp, bright lines
- StarLine paint comes in a 2-1/2 gallon, resealable and recyclable container

WHITE - STARUFW, YELLOW - STARUFY, ORANGE - STARUFO,
 RED - STARUFR, BLUE - STARUFB, BLACK - STARUFBK,
 PURPLE - STARUFP, PINK - STARUFPK

Ultra-Friendly Colors:

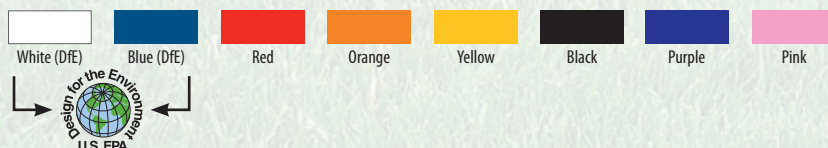

Recognized for
 safer chemistry
www.epa.gov/dfc

Ultra-Friendly White and Blue are currently DFE-recognized paints. Ultra-Friendly Red, Orange, Yellow, Black, Purple and Pink are pending EPA approval for DFE recognition.



Quality, Ease and Performance. All in one convenient and environmentally Ultra-Friendly Package.

STARLINER™
Easy-to-use. Great lines. Environmentally friendly.



A StarLiner™

- Easy-to-use field liner with long-lasting, rechargeable battery
- “Plug & Stripe” technology - simply plug the custom, self-sealing container into StarLiner and stripe with ease
- Convenience of an aerosol striper with the premium look of Pioneer’s Ultra-Friendly paints
- Optional 6’ spray wand attachment

STAR

B Star P.H.D. Ultra-Friendly

Clean your StarLiner as conveniently and easily as you paint with it. Star P.H.D. Ultra-Friendly is tailored for simplicity and environmental friendliness. Just pop off the paint box and plug in the P.H.D. Keep your StarLiner looking and working the way it did on day one, and extend its life, with fast-acting Star P.H.D. Ultra-Friendly.

- Specifically designed to offer “Plug and Clean” technology
- Star P.H.D. Ultra-Friendly comes in a one gallon, resealable and recyclable container
- Recognized by the EPA’s Design for the Environment (DFE) program

STARP1

B



“I love StarLine paint! I stripe several high school fields throughout the area and receive many compliments. StarLine paint is much brighter than aerosols and stands up better on grass. It is more durable, longer lasting, but most of all, it looks more professional than any aerosol I have used in the past.”

John Farmer
Bossier City, LA

“We bought StarLiner for the convenience factor and because it is a cost effective painting system that saves us time. Our students also like that they are helping the environment by not using aerosol cans. I also find it is a lot easier to follow my string and paint a straight line when I do not have to grip the lever on the traditional type of paint sprayer.”

Marc Gilpin
Grounds Supervisor
Fresno Pacific University

“StarLiner operates very easily, from maintenance, to painting to cleanup. I would recommend StarLine paint over aerosol because of the coverage, brightness and durability.”

Mike Wald
Bismarck Park & Rec
Bismarck, ND

StarLiner™ Features:



On/Off switch for spraying

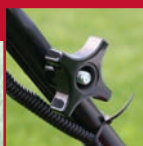

Handle folds for transportation



Telescoping spray arm



Comes with four spray tips



Quick-disconnect paint line



Watch video of StarLiner in action at:

pioneerathletics.com/star

America's #1 Athletic Field Marking Paint

Not standard. Industry standard.



Proven each year at every level of sports... From Friday nights under the hometown lights to Sunday afternoons in professional stadiums.

A Brite Stripe®

Brite Stripe is the number one choice at the pro, collegiate, high school, and recreational levels throughout North America because it delivers an MVP performance every time.

- White lines that are up to 400% brighter under the lights and 25% brighter in sunlight
- High flying colors that are bright and durable even when diluted
- No harm to grass or its growth
- No uniform stains
- No frustrating field striping delays

Brite Stripe® Colors:



Custom colors available.



B Brite Stripe® Airless

Many of our customers claim that Brite Stripe Airless is the brightest line they've ever seen.

- Designed exclusively for airless striper applications
- Optimized viscosity for spraying through airless machines without diluting
- Contains Halogen® 2000 and a slight blue tint for whiter, brighter, longer-lasting lines

Available in standard and custom colors

C Brite Stripe® Pre-Mix

The same great features you expect from Brite Stripe, but already pre-diluted 50/50 for you.

- Saves you time from diluting gallons and gallons of paint
- Perfect for low-pressure machine applications, especially the Pioneer Brite Striper 1500, 1600 and 2000
- Non-settling formula

Available in standard and custom colors

Brite Stripe® Chalk

- A very temporary marking paint for natural grass
- Perfect for short-term special events, camps, drills or instances when a quick field turnaround is needed
- Removes with water, rain, or over time with normal wear

Available in all standard and custom Brite Stripe colors

Brite Stripe® Temporary

- A temporary marking paint for natural grass
- More durable than chalk but less than other field marking paints
- Perfect for special events or games

Available in all standard and custom Brite Stripe colors

Natural Grass Field Marking Paint

Heritage High School
Leesburg, Virginia



GameDay®

When your game is on the line.®

GameDay's premium performance fits perfectly with major events. Customize your athletic field by matching your school, university, or professional colors using the premium pigments only available in GameDay. An exclusive formula for exclusive excellence, this is the paint:

- For championships, playoffs, special events and other nationally televised occasions
- Mixed with a higher concentration of premium pigment and optical brighteners than other natural grass marking paint
- For eye-pleasing optic whites and fan-stunning custom color matches that create pride in your facility
- Also available as GameDay Pre-mix and Airless
- Available in white and custom colors

GameDay® Wheel-to-Wheel

• A variation of our premium Game Day paint that is specially designed for wheel-to-wheel line marking machines.

- Popular on soccer pitches, rugby fields and grass tennis courts

GDW5W

MAX™

The Brilliant, Unbeatable White.

Premium pigments make this line shine. MAX combines a dense and rich formula with great brighteners for closeup-ready results.

- White lines that are up to 500% brighter
- Exclusive white blend containing 150% more prime hiding pigments
- An affordable super-premium paint
- Can be diluted up to 2 to 1
- Available in 3-gallon and 5-gallon pails

MAX3, MAX5

MAX™ TKO

Knocks Out the Competition.

For large jobs that need to stand out, MAX TKO is the paint for you.

- Ideal for large-tank, low-pressure stripping machines
- Highly concentrated athletic field marking paint
- Provides long-lasting, brilliant white lines
- Available in 3-gallon and 5-gallon pails
- Can be diluted up to 5 to 1

TKOW3, TKOR3, TKO03, TKOY3, TKOB3
TKOW5, TKOR5, TKO05, TKOY5, TKOB5

Castleberry ISD
River Oaks, Texas



MAX™ TKO Colors:

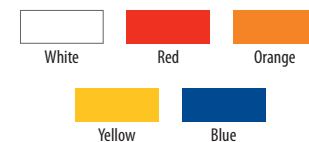

GameDay® colors are customized to the specifications of each individual customer.

Match Play™ Golf Course Turf Colorant

Painting vs. overseeding? Match Play Turf Colorant saves time, money and water.

Course Utilization

Eliminate the course downtime required for bermuda grass germination to take place.

Consistent Turf Color

Match Play colors allow you to choose consistent colors to maintain contrast between greens, collars, tees and fairways.

Water Conservation

Match Play colorized turf requires far less water than overseeded perennial ryegrass.

No Transition Problems

Bermuda grass will green up sooner and more consistently in the spring without competition from perennial ryegrass and poa trivialis.

Ease of Weed Control

Controlling fungi with herbicides and fungicides is easier in dormant bermuda grass as compared to overseeded perennial ryegrass.

Sustain a Stronger Strand

Overseeding over long periods of time can create a weaker strand of bermuda grass.

Lower Maintenance Costs

Eliminate direct cost of seed as well as the indirect maintenance costs of mowing, fertilizing, watering and applying herbicides and pesticides.

Increased Playability

Dormant Bermuda grass can create subtle changes in course conditions, placing more focus on club and shot selection.



Avoid the transition period with the company that is #1 in turf paint. Match Play turf colorant is more durable, affordable, and offers a variety of natural colors.

A Match Play™ Turf Colorant

Introducing an array of turf colorants made specifically for golf courses as an alternative to overseeding with perennial ryegrass. Our colors were developed through a combination of academic research and practical application, creating consistent colors that will not fade to blue.

- BERMUDA GRASS - MPLAYB5
- SOUTHWEST GREEN - MPLAYSWG5
- ULTRADWARF PLUS BLACK - MPLAYUD5
- ULTRADWARF SUPER - MPLAYUDS5

B Walk-Behind Boom Sprayer

Quickly and easily apply Match Play Golf Course Turf Colorant.

- Towable for easy transportation
- Front swivel wheel for maneuverability
- 2-16" Pneumatic tires
- 9 Sprayers on a 4' spray bar for maximum coverage
- Assembly required

BSP48

GREAT FOR ATHLETIC FIELDS!



MatchPlay™ Colors:

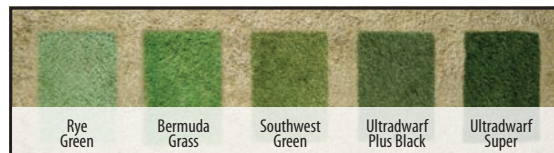

Check out Match Play™ in action. Visit: pioneerathletics.com/mplay

Field Marking Paint Accessories



A Paint Mixing System

- Allows proper and thorough mixing of field marking paint at any dilution rate
- Large, 55-gallon capacity tank with 110 volt motor cuts your prep time so you can give more attention to your field
- Translucent container for better paint visibility
- Fiberglass tank and lid with easy flow gate valve allows for years of trouble-free use
- Heavy-duty, stainless steel stand allows for dispensing into 5-gallon pails
- 1/2 HP mixing motor features ground electrical cord with switch
- Die cast aluminum mixing blades and stainless steel shaft and coupling
- 5-year limited warranty on tank and 2-year warranty on motor

MIX55

B Paint Mixing Blades

- Small blade made of 304 polished stainless steel, and designed for jobs in 1-3 gallon pails and fits any 1/4" electric chucked power tool
- Large blade made of 304 polished stainless steel, designed for jobs in 5-10 gallon containers, and fits any 1/2" electric chucked power tool

SMALL - F15, LARGE - F21

C Mixing System Pump

- 6' hose with 3/4" gasoline-style shut off valve
- Secures directly to the pump of the Pioneer mixing system allowing direct transfer of paint to field marking machine tank or pail

MIX55P

D Large Paint Funnel

- 13" opening allows you to dispense your paint with less mess

FUNNEL

E Paint Strainers

- 100% nylon with elastic garter-top for 1 & 5 gallon pails allows for premium paint mixture
- 25 Per Box

1-GALLON - PS50, 5-GALLON - PS25

F Reusable Paint Strainer

- Strainer inserts lie on top of any 3 or 5 gallon open-head pail, allowing valuable material to be poured through easily while removing unwanted coarse particles.
- The patented lip design ensures that the strainer always stays in place
- A great tool for cleaning parts over a pail, while capturing cleaning solution below

PS5

G Premium Lid Remover

- This lightweight aluminum lid opener allows you to open paint pails in seconds

LIDR

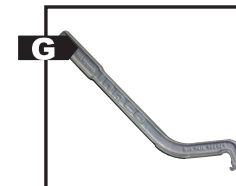
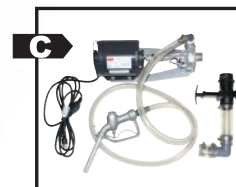
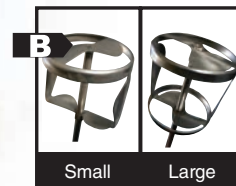

Visit us at: pioneerathletics.com/pa
to see our full line of accessories.

Aerosol Field Marking Paint



Pioneer Aerosol Stripers

- Works with paints in both 20 oz. and 24 oz. can sizes
- Large, 10" semi-pneumatic wheels and wide axles provide a smooth roll

MAX™ Striper - MVPM1
Quik Striper® - QSM

Use with:



Premium Aerosol Striper

- Maximize the quality of the lines on your field
- 8" pneumatic wheels roll smoothly over rough fields and provide crisp striping

PVIPPM

Use with:



Premium 2-Can Aerosol Striper

- Cover both sides of the grass blades in a single pass
- 8" pneumatic wheels roll smoothly over rough fields and provide crisp striping

MVPM2

Use with:



Aerosol Marking Stick

- New design for increased durability and usability
- Available for 20 oz. and 24 oz. cans
- Longer and easier than ever before with a new, ergonomic grip and responsive finger-tip trigger
- Comfortable, free-hand marking
- Gets you closer to stencils
- Enjoy lightweight, sturdy construction

MAX, PVIP & GAMELINE - PSTICK
QUIK STRIPE - QSTICK



Aerosol Marking Pistol

- New design for increased durability and usability
- Available for 20 oz. and 24 oz. cans
- Comfortable, free-hand marking
- Gets you closer to stencils

MAX, PVIP & GAMELINE - PVIPMP
QUIK STRIPE - QSMPP



Breast Cancer Awareness Stencil
& Paint Kits available at:
pioneerathletics.com/ribbon



MAX™ Aerosol

Exclusive MAX formula comes with proven MAX performance.

- MAX is the solution for those who want the brilliance of MAX liquid bulk paint with the convenience of an aerosol
- MAX uses premium pigments and a rich formula for more prime hiding
- No harm to grass or its growth

Available in 20 high-performance colors.



Quik Stripe®

Count on Quik Stripe, the industry-leading aerosol marking paint for those who care most about their fields.

- So ready-to-use, and quick drying, it's built right into the name
- The best in brightener technology with no clogs, waste or mess
- Crisp, clear lines even in severe weather
- No harm to grass or its growth

Available in 20 high-performance colors.



PVIP™

The versatile aerosol paint, outfitted with value, performance, brightness and paint crew satisfaction.

- Save time and money, plus get 22% more paint per can
- Durable and dependable on game days
- All without clogs, waste and mess
- No harm to grass or its growth

PVIP available in Arctic White only.

PVIPW12



MAX™ & Quik Stripe® Chalk

Temporary marker for natural grass and synthetic turf. Tested for use on synthetic turf, will not stain or leave behind ghosted markings.

- Perfect for creating temporary field markings for camps and drills, or other temporary marking, even on concrete
- Can be sprayed with a Pioneer Aerosol Stripping Machine, Marking Stick, Pistol, or by hand. Removes with water, or over time with normal wear or rain

QUIK STRIPE

WHITE - QSWC12, YELLOW - QSYC12, ORANGE - QSOC12, RED - QSRC12, BLUE - QSBC12

MAX

WHITE - AMAXC12, YELLOW - AMAYC12, ORANGE - AMAXOC12, RED - AMAXRC12, BLUE - AMAXBC12

MAX™ and Quik Stripe® Colors:

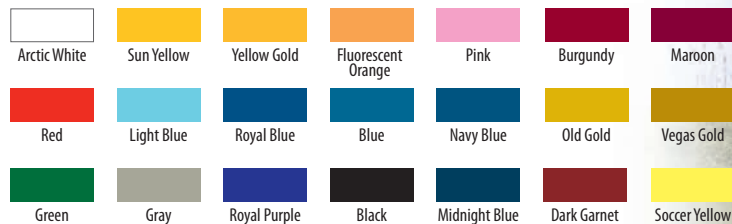

MAX™ and Quik Stripe® Chalk Colors:

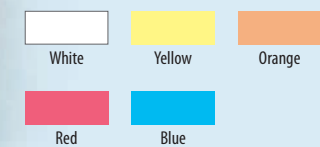

Field Painting Layout Tools

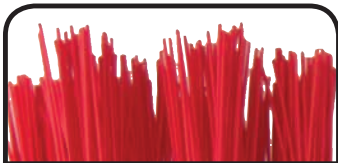

UV-resistant synthetic grass tufts are mower resistant and highly visible.

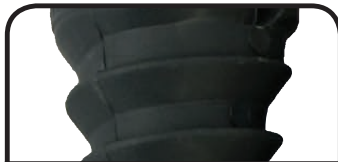

Recycled polypropylene spiral cone base remains in place and is difficult to remove.



Available in Yellow, Blue, Red, Orange, White, and Green

PleeFix™ Ground Markers

- UV-resistant synthetic turf tufts
 - Fibers available in yellow, blue, red, orange, white, and green
 - Recycled polypropylene spiral cone base
 - Use to mark sprinkler heads and other potential field hazards
 - Eliminates the need to re-measure natural grass fields prior to painting
 - Can be used on sports fields for football, soccer, lacrosse, field hockey, rugby, baseball/softball, track and field, and golf
 - Highly visible and mower resistant
- Orange - PFO25; White - PFW25;
Blue - PFB25; Yellow - PFY25;
Red - PFR25; Green - PFG25;
Mixed Box - PFM25

See Full Product Details on back cover

Watch the installation video at:
pioneerathletics.com/pleefix



Battle Boards

Heavy-duty, yet highly flexible plastic boards used for masking while painting precise, straight lines or sharp, crisp curves on the field. Battle boards come in a variety of sizes to meet your specific field painting needs.

4' x 1' - BB4



Marksmart Football Kit Shown Here

Marksmart™ System

- Eliminates the need for repeated field measuring and staking
- Sockets permanently locate and identify line intersections
- Simply insert pegs into sockets and attach string
- Follow string lines to paint field
- Available systems: basic, football intramural and soccer
- Individual components also available

FOOTBALL - MSFOOT; SOCCER - MSSOCCER; BASIC - MSBASIC; INTRAMURAL - MSINT



Basic Cord & Reel

- Easy-to-use guide for the layout process
- Utilizing the kit will cut your layout time significantly
- Kit helps you to lay out field faster and more accurately
- Available for football, baseball, soccer field hockey, boys and girls lacrosse and general use with 500' or 1200' of cord



Ground Markers

- 6" Nail spike with colored bristles
- Easy-to-install and highly visible
- Available in blue, orange, red, yellow and white
- Pack of 25

BLUE - GMB25, GREEN - GMG25,
ORANGE - GMO25, RED - GMR25,
WHITE - GMW25, YELLOW - GMY25



400' Measuring Tape

- Heavy-duty polyethylene case
- Easy-turn rewind system
- PVC coated fiberglass, double-sided tape shows feet and meters
- Other sizes available

MT400

Grounds Maintenance



Turf Gro™ Blankets

- Helps accelerate seed germination, allowing athletic fields to recover from high usage
- Helps protect turf, promoting stronger and healthier root growth
- Made of high strength, lightweight polypropylene fabric
- Helps to minimize damage from winterkill, wind and insects
- Extends growing season allowing for earlier green-up of sports fields
- Available in standard 2 oz. or premium 3.2 oz.
- Has grommets and hemmed edges
- Premium Turf Gro Blanket includes storage bag
- Stakes available for securing position



Tracker™ Traveling Sprinkler

The portable irrigation machine.

- High quality materials
- Minimal labor to operate
- Adjustable speed control for easy water adjustment
- Standard full or part circle sprinkler with robust turbine drive
- Ideal for irrigating athletic fields, golf courses and parks

TRACKER



Magnum™

- Fire hose quality nozzle feels great in your hands
- Ultra-durable construction withstands any abuse
- Solid metal interior - no plastic parts to break or wear out
- Ratchet prevents over-tightening
- 3/4" Inlet Thread

MAGNUM; MAGNUM ULTRA (1" Thread)



Hot Shot

- Super heavy-duty construction features aircraft aluminum with high composite components
- Fully adjustable flow control from a strong jet stream to a mist
- Quick on/off setting
- 1" Inlet Thread

HOTSHOT



Ultralite

- A multi-purpose, lightweight, rigid 1" diameter high pressure irrigation hose
- Meets the needs of golf, sports turf and all irrigation market applications.
- Abrasion resistant, all polyester cover with polyurethane coating
- Special helical interior reinforcement to retain rigid shape.
- Available in 50', 75', and 100' lengths

50' - HOSE50HP, 75' - HOSE75HP, 100' - HOSE100HP



1" Clear Water Hose

- Reinforced with spiral polyester yarn and longitudinal tracer yarns to reduce elongation under pressure
- Superior weather, ozone, and ultraviolet resistance
- Clear color allows visual confirmation of product flow
- Working Pressure rated @ 125 PSI and Max. Burst Pressure @ 500 PSI
- Available in 50', 75', and 100' lengths

50' - HOSE50C, 75' - HOSE75C, 100' - HOSE100C



1" Heavy-Duty Hose

- For high volume water uses, such as athletic fields, golf courses and parks
- Maximum industrial reinforcing
- Kink resistant quality
- Available in 50' and 100' lengths

50' - HOSE50, 100' - HOSESM

GameLine® Removable System for Synthetic Turf

Proven performance. **Proven** removability. **Proven** quality.



Pioneer's GameLine is the Only Synthetic Turf Paint Recommended by Every Major Synthetic Turf Company.

A GameLine®

GameLine is the perfect call when you need quality gloss paint that lasts one or two games and removes easily with no ghosting or residue.

- Highly effective, industry proven removable synthetic turf painting system
- Maximum performance under the spotlight
- Ideal for short-term applications
- Removes easily with no ghosting thanks to Blitz™ GameLine Remover Solution
- Ideal for infilled turf systems

GameLine® Colors:



CUSTOM COLORS AVAILABLE

GameLine® Clear

- A clear, removable synthetic turf paint available in bulk and aerosol
- Used as a base coat before painting over inlaid lines and logos, making removal much easier

GameLine® Subzero

- Designed for application when temperature falls below freezing
- Increases opportunities to paint synthetic turf with bulk paints in colder climates
- Special formula cures at lower temperatures and reduces the likelihood of paint clogging a machine due to freezing

The paint used at the 2013 & 2014 Super Bowls!



Stonehill College
North Easton, Massachusetts



A Blitz GameLine® Remover Solution

- Easily and quickly remove temporary synthetic turf paint, logos or stencils
 - Just apply, agitate with Blitz Remover Machine, then wash away with water
 - Blitz GameLine Remover Solution is designed to work with GameLine Removable Paint
- 5 GAL - TB05, 55 GAL - TB55



B Blitz HT GameLine® Remover Solution

- GameLine synthetic turf paint remover solution is designed for the hours when field temps are at their peak
- Helps remove temporary synthetic turf paint when field surface temperatures are at their peak -- generally between 11 a.m. and 3:00 p.m.
- Just apply, agitate with Blitz Remover Machine, then wash away with water
- Blitz HT Remover Solution is designed to work with GameLine Removable Paint

TB05HT

C GameLine® Aerosol

The only industry-proven removable aerosol paint for synthetic turf fields.

- Convenient, easily removable paint with the quality and durability of a permanent paint
- Ideal for short-term applications
- Removes easily with Blitz GameLine Remover Solution
- The only aerosol paint proven to remove with zero ghosting or staining
- High gloss

WHITE - GLAW12, YELLOW - GLAY12, ORANGE - GLAO12, RED - GLAR12, BLUE - GLAB12, BLACK - GLBK12, PINK - GLAP12, TURF GREEN - GLATG12, DARK TURF GREEN - GLADTG12

D Quik Stripe® Chalk

E MAX™ Aerosol Chalk

Temporary marker for natural grass or synthetic turf.

- The only aerosol marking chalk proven to remove with zero ghosting or staining. For more information on Quik Stripe and MAX Chalk, See page 11



GameLine® Aerosol Colors



Quik Stripe® and MAX™ Chalk Colors

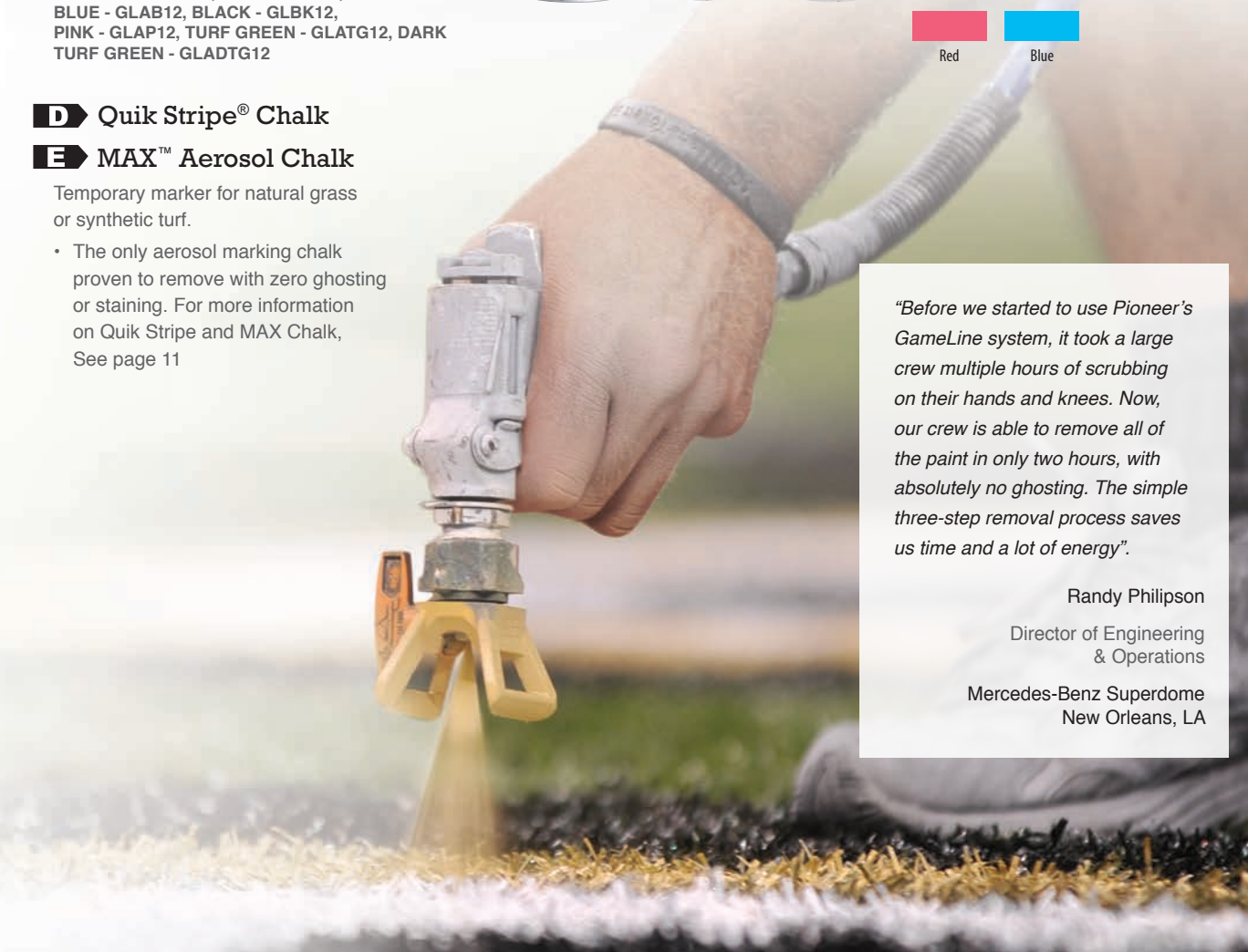

"Before we started to use Pioneer's GameLine system, it took a large crew multiple hours of scrubbing on their hands and knees. Now, our crew is able to remove all of the paint in only two hours, with absolutely no ghosting. The simple three-step removal process saves us time and a lot of energy".

Randy Philipson
 Director of Engineering & Operations
 Mercedes-Benz Superdome
 New Orleans, LA

Synthetic Turf Field Marking Paint

Durable paints designed specifically for synthetic turf fields.

For use on polypropylene turf

For use on nylon turf



ExtremeLine™

Synthetic Turf Marking Paint for Long-Lasting Applications

- Preferred choice for infilled systems
- Extremely durable marking paint for long-lasting applications
- Provides a uniform, high-gloss field marking with less paint build-up
- 50% more durable and longer lasting than our already resilient formula

SeasonLine®

Excellent Coverage and Durability.

- Quality, gloss paint that stands up to rugged play
- Wears off over time, depending on weather and traffic
- For use on infilled turf systems

Titan®

- Exclusive formula contains Halogen® 2000 for outstanding brightness
- Creates long-lasting lines
- Maintains flexibility and crisp, bright lines throughout the season and severe weather
- Dries to a smooth, flexible coating which is less abrasive to players and less slippery than other turf paints

Titan® Extreme

- Glossy paint for nylon surfaces
- Increased durability
- Softer, more flexible paint that evenly coats nylon synthetic turf blades
- Mimics the feel of the turf itself



Mount Union College Alliance, Ohio

ExtremeLine™, Titan®, Titan® Extreme, and SeasonLine® Colors:



Custom colors available.

Pioneer Remover and Extractor Machine

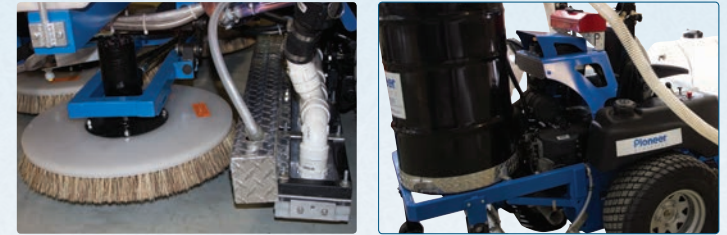

P-REX™

All-in-one tool for removing GameLine® synthetic turf paint.

- Kawasaki 852 cc gasoline engine electric start
- Dual hydrostatic high torque wheel drive motors
- Two 35 gallon rinse water holding tanks
- 15 gallon GameLine Blitz paint remover solution tank with hand held spray wand
- 60" rear mounted boom sprayer to apply the GameLine® Blitz paint remover solution
- 55 gallon recovery drum with powerful dual vacuum motors
- 60" wide vacuum head with built in rinsing spray boom and electric lift has specially designed perforations for high pressure suction and minimal infill removal
- 3-20" scrubbing brushes with electric lift that create a 60" wide paint removal path
- All wheels have spray nozzles to remove paint and minimize paint tracking
- Front mounted spray nozzles for optional water or GameLine® Blitz paint remover solution applications
- 5500 watt belt driven on-board generator
- Panel mounted control switches for fingertip control while operator is seated

EXTRACTOR

Synthetic Turf Maintenance Equipment



**New
Brush
Pattern**

Shown here with the new front-end spring tine rake



A Field Crewzer™

Pioneer's Field Crewzer is the premier sweeper that removes litter and debris while returning infill back into the field.

- A robust, counter-rotating brush lifts surface debris into a primary hopper
- Infill granules are returned to the surface while debris is shaken into one of two easily-removable hoppers at the rear of the machine
- Can be pulled by most golf carts and utility vehicles
- The Field Crewzer is lifted up by electric actuator for transporting

CREWZER

B Crewzer™ Junior

- Features a ground-driven rotary brush that picks-up surface debris and minimal crumb rubber infill
- A mechanical, vibrating screen separates debris and infill
- Infill is evenly redistributed onto the field
- Debris is collected in an easily removable hopper

CREWZERJR

GreensGroomer®

The GreensGroomer is a synthetic sports turf groomer that works with all infill material.

- Patented brush design with super-duty brushes lifts turf fibers, leaving them in a plush, upright position
- New brush pattern increases efficiency and performance when brushing infill to low areas left after play
- Synthetic brushes resist wear and will not rot
- Optional Spring Tine Rake consists of 3 rows of 28 tines, spaced 7/8" apart for thorough coverage that combs through infill, relieving compaction and assuring a soft, level playing surface
- Spring tine rake now placed on front end of groomer
- Optional 6' tow-behind magnet available for collecting ferrous material hidden in the field and infill

GREENSGROOMER - GG720SDE
SPRING TINE RAKE OPTION - GGSTR
MAGNET OPTION - GGMAG

LitterKat®

Removal of surface debris from synthetic turf fields has never been easier.

- Ground driven sweeper designed to remove debris from the turf surface without displacing infill material
- 12-volt actuator for easy brush depth adjustments
- Dual 12-volt vibrators in the collection baskets allow any infill material that is collected to be quickly returned to the field
- All aluminum construction with a durable powder coat finish allows the LitterKat to be towed by most utility vehicles
- Equipped with a powerful 6' tow-behind magnet that pulls unwanted ferrous material from deep within the infill

LITTERKAT



C Blitz Walk-Behind Remover Machine

- Easy-to-use brush engagement
- 5.5 HP Honda engine
- 7 Adjustable positions for height of brush
- 8" Pneumatic wheels
- Padded handle collapses for easy storage and transport

TRMWB



Check out the full library of Pioneer's Field Equipment videos. visit: pioneerathletics.com/stequip

Synthetic Turf Accessories



mPact-4-Turf

- Powered by AEGIS Microbe Shield® technology.
- Imparts a durable, invisible barrier which is protected from odors and stains caused by bacteria, mold and mildew.
- Ideal for treating heavy traffic areas like sidelines and coach's boxes. Designed to last for up to 30 days between applications



Titan T.G.

- 5 gallon pail of highly dilutable, one-step disinfectant
- Kills harmful microbes that can cause disease on plastic surfaces
- EPA registered, neutral pH for player safety
- Also available in 55 gallon packaging TTG05



Battery Operated Backpack Sprayer

- Sprays at 40 PSI for up to 120 gallons on a single charge with a 12 volt, 7.0 Amp/Hour battery and 4 gallon tank
- BPSB**



Premium Backpack Sprayer

- 4.8 gallon tank, 29.5 wand length, 90 psi operating pressure, and 69.7 hose length
- BPSB**



Digital Infrared Thermometer

- Check the heat of your synthetic turf field for players' safety
- Offers laser targeting accuracy, enhanced back-lit LCD display and expanded temperature range of 2°C - 500°C, -4°F - 932°F

THERMO

Gawryla Grip Replacement Pins Also Available



Gawryla Grips™

Synthetic turf field lining system. Lining an artificial turf field in preparation for painting lines used to mean puncturing the turf with nails or stakes. The Gawryla Grip holds firmly without damaging the turf, providing a solid anchor for stringing lines.

GRIP; REPLACEMENT PINS - GRIPP



Synthetic Turf Repair Kit

- A two-component, 100% epoxy adhesive designed for high strength repairs of artificial turf
- Meets FIFA standards for bond and shear strength
- Kit contains 6 cartridges, 12 static mixers, 1 dual-cartridge assembly gun, 1 tool box

STRK



Premium urethane artificial sports-turf repair adhesive

Ultrabond® Turf 527

- A moisture-curing, one-component, polyurethane adhesive specifically designed for the repair of existing outdoor turf
- For interior and exterior applications, excellent weather resistance.
- Meets FIFA requirements for bond and shear in sports-turf applications.

STRC

Airless Field Marking Machines



**BRITE STRIPER®
3000**



**BRITE STRIPER®
3000^{SP}
SELF-PROPELLED**

A Brite Striper® 3000 **B** Brite Striper® 3000 SP

Power and versatility in an affordable airless sprayer. Pioneer's airless strippers offer the newest advances in industry proven airless striping technology, the highest level of performance, and a model to fit every budget.

Both models feature:

- Sturdy and lightweight frame
- Phenomenal reach thanks to a 50' hose for logos and wide-area spraying
- Smooth ride, even on rough fields, thanks to large pneumatic tires and optional floating spray box
- Steady, adjustable air pressure from 0-3000 PSI
- Warranty-backed Honda GX160 engine

Brite Striper 3000 SP (Self-Propelled) adds:

- Breakthrough belt-and-chain drive system and adjustable speed to deliver great, straight lines
- Optional 15-gallon paint hopper- 2708

BRITE STRIPER 3000 - BS3000
BRITE STRIPER SELF PROPELLED - BS3000SP

Brite Striper 3000SP and Brite Striper 3000



Adjustable handle & storage compartment



Honda GX160 engine



Pressure adjustment control



Pressure gauge



Nozzle atomizes paint for great coverage



Self-propelled system engagement handle



Optional 15-gallon paint hopper

All Pioneer Airless Field Strippers are recommended for use with:



Brite Stripe, Brite Stripe Ultra-Friendly, Brite Stripe Airless, Brite Stripe Pre-Mix



MAX



GameDay, GameDay Pre-Mix, GameDay Ultra-Friendly



GameLine



Titan, ExtremeLine, SeasonLine



FastLane



Graco® Airless Field Marking Machines

Pioneer is an authorized Graco dealer and carries a full line of parts, accessories and striper.



Graco® FieldLazer S90

Spray bright professional lines with the industry's first high pressure battery powered field striper. Battery powered simplicity is now combined with Graco's professional, paint saving high pressure technology:

- One button operation - add paint and press the button to start.
- 12V rechargeable, maintenance-free battery - 10 soccer fields or 1 football field per charge
- Eco-friendly - eliminates aerosol can waste, conserves paint & water, no emissions or propellants
- Tilt-N-Pour removable 6 gal. hopper

248942



Graco® FieldLazer S100

When the ground gets rough, the FieldLazer S100 gets going. If you've got rough terrain, then take a look at this:

- A tall-wheel, lightweight cart designed for rough terrain
- Easy-to reach operator controls located on the handle, including a safety shut-off switch for shutdown
- A dependable Honda GX35 4-stroke engine

248942



Graco® FieldLazer S200

Meet your new rear-gun-mount specialist. The FieldLazer lives up to its name: 60% less vibration at the spray tip compared to other rear gun mount sprayers makes for precise lines. With the FieldLazer S200 you get:

- The ability to place guns near the rear axle for applying straighter long lines and smooth curved lines
- Better gun visibility
- A reliable Honda GX120 engine

24M609



Graco® FieldLazer R300 Complete

All-in-one ride-on system consists of a LineDriver™ HD ride-on system and FieldLazer R300 field marker (also available separately).

- Advanced Vibration Reduction System that eliminates vibration for improved line quality
- Flow-through Easy Out filter comes out with the cap for convenient, mess-free access
- A reliable Honda GX120 engine

24M605



Graco® G400

All-in-one stand-on, self-propelled field marking machine.

- Throttle, choke, and engine pull cord controls accessible from standing operator position
- 25 gallon easy clean paint hopper
- Front (improved visibility) or rear (tight radius) mount gun
- Forward speeds to 10 mph (16 km/h), reverse speeds to 6 mph (10 km/h) - change directions instantly for consistent lines
- A reliable Honda GX270 engine

24M608



Recognized for safer chemistry. www.epa.gov/dfe

P.H.D. Ultra-Friendly

Specially designed cleaning concentrate for athletic field marking machines. Fast acting P.H.D Ultra-Friendly leaves no soap scum or residue. Keeps athletic field markers clean and bright for better performance and longer life.

4 x 1 gal. - PHDUF4, 12 x 1 qt. - PHDUF12
5 gal. - PHDUF5

Throat Seal Oil

Formulated to prevent paint from drying on the displacement rod, throat seal oil extends the life of throat packings and the piston rod.

8 oz. bottle - 2501

Pump Conditioner

Designed to stop corrosion and paint build up within the airless spray system.

32 oz. bottle - 2502



Low Pressure Field Marking Machines



Battery Powered

Brite Striper® 1100

Battery-operated versatility, professional results.

Handle all your athletic fields with ease and get the results you want. No need to compromise.

- Premium 12V battery with charger (included)
- 4-position handle
- Fully-adjustable 2" - 8" spray box
- Easy-to-clean, just flush with 5-gallon pail of fresh water
- Draws from 3 or 5-gallon pail
- Semi-pneumatic wheels to guide over rough terrain
- Optional hook up for any Pioneer hand hose

BS1100



Brite Striper® 1400

CO2-Powered Simplicity. Professional performance with simplicity of operation and control - and no gas.

- CO2 powered for about 210 gallons of paint per tank
- 7-gallon stainless steel tank
- 4-position handle
- 24" wand with 12' hand hose
- Semi-pneumatic wheels to guide over rough terrain
- Optional 2-headed sprayer, 12-gallon stainless steel tank upgrade and Power Clean tank cleaning system

7 GALLON TANK - BS1400

12 GALLON TANK - BS1400U



Brite Striper® 1500

The favorite of over 4,000 customers. Universities, high schools, parks and recreation departments, and professional teams rely on their Brite Striper 1500.

- Honda GX100 Engine
- 7-gallon stainless steel tank
- 4-position handle
- 24" wand with 12' hand hose
- Semi-pneumatic wheels to guide over rough terrain
- Optional 2-headed sprayer and Power Clean tank cleaning system

BS1500H

Pioneer low-pressure machines are recommended for use with:



Brite Stripe, Brite Stripe Ultra-Friendly, Brite Stripe Pre-Mix

MAX

GameDay, GameDay Pre-Mix, GameDay Ultra-Friendly

Titan



Two-Headed Sprayer

Standard on the Brite Striper 1600 and is available as an accessory for the 1400, 1500, and 2000.

1523

Retractable Spray Gun

25' hose makes spraying logos and wide-area spraying easier than ever and prevents tangling.

0026





Brite Striper® 1600

Two-headed efficiency for quick, quality work.

Cut your striping time in half with the efficiency, effectiveness and durability of the 1600.

- Honda GX100 Engine
- 12-gallon stainless steel tank
- 4-position handle
- 24" wand with 12' hand hose
- 2-headed sprayer
- Semi-pneumatic wheels to guide over rough terrain
- Optional Power Clean tank cleaning system

BS1600PS



Brite Striper® 2000

Self-propelled, hydraulic-driven bliss.

With the 2000 you get self-propelled forward and reverse without slippage or pushing.

- Honda GX120 Engine
- 12-gallon stainless steel tank
- Variable speed, hydraulic drive, self-propelled drive system with reverse
- 4-position handle
- 24" wand with 12' hand hose
- Semi-pneumatic wheels to guide over rough terrain
- Optional Power Clean tank cleaning system
- Optional 2-headed sprayer

BS2000HPC



NewRider 5000

- The NewRider 5000 HP is the first true ride-on airless paint striper machine
- Front wheel drive with rear steering
- 30" seat height & center spray gun provides maximum visibility to existing lines or layout string
- Fully adjustable, 0-3000psi pump pressure
- Floating spray gun for maintaining line width over rough terrain
- Adjustable, tilt steering column
- On-board 2.5 gallon purge tank lets you clean spray gun and hose 'in-the-field'
- In-line filter keeps you running without clogs.
- Quick-release clamp and 25' hose allows you to remove the spray gun to spray stencils, small curves and hard to reach areas
- A 14 hp Subaru-Robin OHC engine with electric start
- 50 gallon poly tank: stripe up to four football fields or seven full-size soccer fields with one filling
- 36 month warranty

NR5000

VISIT WWW.PIONEERATHLETICS.COM FOR MORE INFO



Wheel-to-Wheel Line Painter

A simple, durable and easy to operate liquid transfer line painter. Paint is transferred from the 15 liter (3.96 gal.) hopper to a 4" wide marking wheel – providing even and accurate lines. The unit features adjustable, steel tube handles and pneumatic tires.

W2W



Get a **FREE** quart of P.H.D. Ultra-Friendly with the purchase of any new low pressure Pioneer Brite Striper®.



Recognized for safer chemistry.
www.epa.gov/dfe

P.H.D. Ultra-Friendly

Specially designed cleaning concentrate for field marking machines. Fast acting P.H.D. Ultra-Friendly keeps athletic field markers clean and bright for better performance and longer life.

4 - 1gal -PHDUF4, 12 - 1qt -PHDUF12, 5 Gal -PHDUF5

Custom Stencils

A Custom Stencils

Some people call it a logo or a team mascot mark. We have the resources to help you make it much more than that. Choose Pioneer, and get athletic stencils as rugged as an all-conference defensive line, with the toughness of 60 mil. polyethylene plastic panels, Poly-Tuff and a variety of other materials to suit your needs and budget. The latest stencil technology is at your disposal, so adding your logo or mascot is easier and more affordable than ever before. Just as importantly, finished products are lightweight enough for one person to handle, made with fewer pieces, pre-marked for quick assembly and easy to clean. It all adds up to years of use and satisfaction. Make your field the most colorful member of the team. Give it distinction and class. Order your custom stencil today. **To get your field stencil going, call Pioneer at 800-877-1500 or email: stencils@pioneerathletics.com**



A



B One-Piece Tracing Pattern

Pioneer's heavy-duty full end zone tracing pattern stencils are fabricated with thick and durable polyethylene plastic and can be folded for convenient storage. Enhance the look of your field by ordering a custom full end zone tracing pattern stencil today.

- 1-piece construction allows for minimal set-up and storage
- Available up to 35' X 80' (call for custom end zone size template quote)
- Durable .006 mil. standard/semi-clear polyethylene plastic
- Vinyl tab grommets (6 standard: 4 corners and one on center of top and bottom)
- Re-usable

LOOKING TO CUSTOMIZE YOUR FIELD? CALL US AT:
800-877-1500
 OR EMAIL:
artwork@pioneerathletics.com
 AND ASK ABOUT OUR CUSTOM STENCILS.

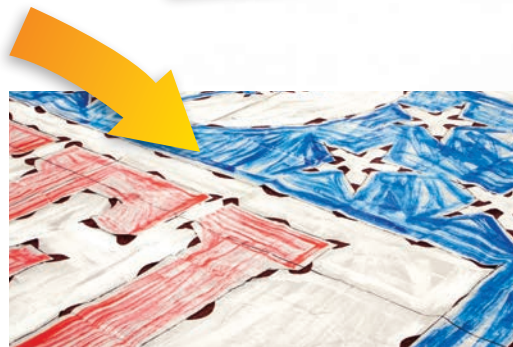

Painted One-Piece Tracing Pattern Now available!

Now available - Pioneer's One-Piece Tracing Pattern with a painted guide option to help distinguish between color breaks in the design. Call 800-877-1500 today for details!



Optional grommets available at each corner of stencils!



Check out all of Pioneer's field stencils. Visit us at:
pioneerathletics.com/stencils

Standard Stencils

ABCDEFGHIJKLM
NOPQRSTUVWXYZ

ROMAN

ABCDEFGHIJKLM
NOPQRSTUVWXYZ

BLOCK

ABCDEFGHIJKLM
NOPQRSTUVWXYZ

ATHLETIC

012345G▲

ROMAN

012345G▲

BLOCK

012345G▲

PRO STYLE



Letter Stencil Kit

Let your opponent know exactly whose turf they're on. Add your school's nickname or initial to your field. Letters come in Roman, Block or Athletic. Eight standard sizes up to 30 feet high.

Number Stencil Kit

Don't let your players lose sight of where they are going on their way to scoring a touchdown. Standard kit includes numbers 0-5, the letter G, and an arrow. Standard sizes: 3' and 6' high.

Hash Mark Stencil Kit

Make every yard count. Kit includes four 1-yard hash marks in 1 or 2-piece hinged stencils.
1-PIECE - SF6070D, 2-PIECE - S6070D



Promote Awareness with a Stencil & Paint Package from Pioneer Athletics

The package includes a 6' x 10' ribbon stencil (3-piece, 1/16" thick polyethylene) and your choice of one of the following four packages:

PACKAGE 1
2 cases of Quik Stripe Pink
Aerosol field marking paint for natural grass
RSPQS

PACKAGE 2
2 cases of MAX Aerosol Pink
Aerosol field marking paint for natural grass
RSPM

PACKAGE 3
5-gallon pail of Brite Stripe Pink
Liquid bulk field marking paint for natural grass
RSPBS

PACKAGE 4
5-gallon pail of GameLine Pink
Removable field marking paint for synthetic turf
RSPGL

PACKAGE 5
1 case of GameLine Aerosol Pink
Removable aerosol field marking paint for synthetic turf
RSPGA

Ribbon Stencil Only: ST106R



Aluminum Hash Mark Stencil

Pioneer's athletic field stencils are as rugged as your defensive line.

- Sturdy, 2-piece, slide-together construction with locking pins helps make accurate and crisp lines
 - 15' total length with folding handles for easy storage
 - Lightweight, all aluminum construction
 - Wheel kit can be added to make it a one person operation
 - Foam edges can be added to help prevent paint run-off
- AHS

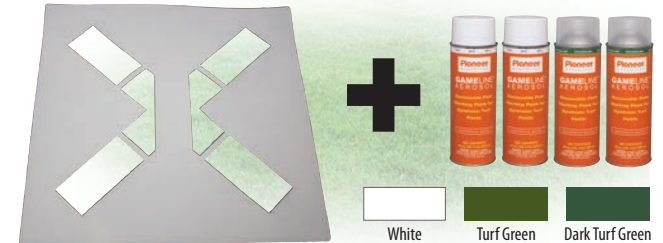

Kickoff Stencil Package

- Paint and stencil kit designed to cover up the old location for kickoffs and paint in the new location required by the new rule change in kickoff location
- Comes with 2 cans of GameLine Removable Aerosol White and 2 cans of GameLine Removable Aerosol Turf Green or Dark Turf Green

STENCIL + WHITE AND TURF GREEN: KICKOFF;
STENCIL + WHITE AND DARK TURF GREEN: KICKOFF2

Baseball Accessories

Infield covers and mats.

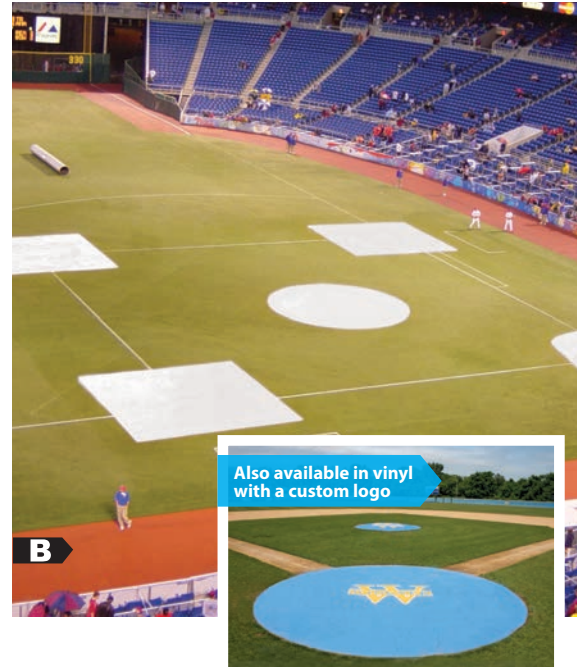

A Full Infield Covers

- Protects full infield from multiple forms of punishment
- High-strength, long-lasting, reinforced PVC and polyethylene fabrics with pull handles
- Waterproof and rot resistant
- Sandbag anchors or stakes available

FICOVERS

B Spot Infield Covers

- Protect the pitching mound, batters boxes, home plate and bases from rain and harsh weather
- Lightweight and easy to handle
- Available in 6 oz. silver poly or 18 oz. vinyl in 14 colors call for details
- Includes grommets at 3' - 4' intervals and stakes for anchoring

SICOVERS

C Infield Protector Mats

- Helps protect turf during batting practice
- Heavy-duty mesh for use in front of batting cage and other high-wear areas
- Same fabric used by major league baseball teams
- Batting Practice Collar Protectors (2 or 3-piece) available call for details

IFPSM

D Weighted Spot Covers

Stay put in high winds without stakes or sandbags.

These are the famous Major League style rain covers now used by every level of baseball.

- Chain in the entire edge keeps wind from getting under, so it doesn't blow away
- Available in 6 oz. silver/white poly or 18 oz. vinyl in 14 colors - call for details
- Standard diameters: 10', 12', 18', 20', 26', and 30'

IWMCOVER

Baseball Accessories

A Line-Pro® Chalk Liner

- 50 lb. unit is versatile enough to stripe baseball fields, football fields, soccer fields and recreation areas
- Body design is a wedge shape to ensure a constant flow of chalk to the bottom of the liner
- Fingertip control allows you to adjust the thickness of your line and control the shut-off of chalk
- Provides a high quality 2" or 4" line
- 10" rubber diamond-tread wheels provide minimum rolling resistance
- 25 lb. unit available

50 LB. - LINE50P, 25 LB. - LINE25

StreamLiner 70 lb.

StreamLiner 35 lb.



B StreamLiner 70 lb. & 35 lb.

- Professional grade dry line markers
- Durable - made for years of use
- Works well in any weather
- Provides high-quality 2" or 4" lines
- Semi-transparent hopper cover makes for easy viewing of chalk levels inside of the unit's hopper
- Retractable handle makes the unit fit into any on-field storage box that is 30" or higher

35 LB. - STRM35P, 70 LB. - STRM70

C Crystalline Marble Chalk

- Premium field marking chalk made from crystalline marble dust
- For use with the Line-Pro® or StreamLiner dry marking liner
- Environmentally friendly
- Brilliant white in color
- Comes in a 50 lb. bag

22399PPD



MAX™ & Quik Stripe® Aerosol Chalk



Temporary marker for natural grass and synthetic turf. See page 11.

MAX™ & Quik Stripe® Aerosol



Available in 20 high-performance colors. See page 11.

Baseball Accessories

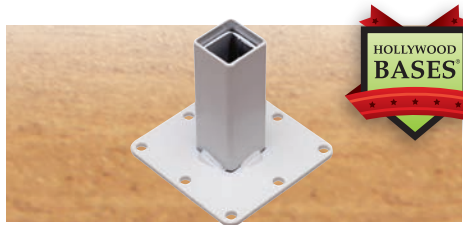

Stanchion Converter

- Easily converts a sleeve-style base to accept a male (post) ground anchor
- 12916532



Dual Stanchion Pitching Rubber

- Available in 10" Dual Stanchion Rubber or 24" Dual Stanchion Rubber
- 12920704

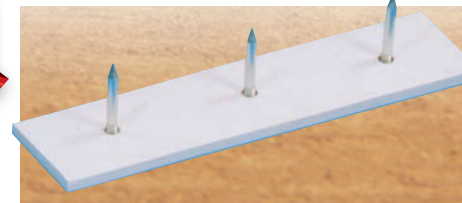

3 Spike Pitching Rubber

- Reinforced threaded steel spike fixtures
 - Three nickel-plated steel spikes
 - Heavy-duty, UV resistant rubber
 - Available in youth sizes
- STANDARD: PRR; YOUTH: PRRY**



Step Down Pitching Rubber

- Two-level molded construction prevents uneven holes in front of rubber
 - Buries for permanent installation
 - Heavy-duty, UV resistant rubber
 - Available in youth sizes
- STANDARD: PRSD; YOUTH: PRSDY**



4-Way Pitching Rubber

- 4-sided design insures flat surface can be rotated for many years of use
 - Heavy-duty, UV resistant rubber
 - Available in youth sizes
- STANDARD: PR4; YOUTH: PR4Y**

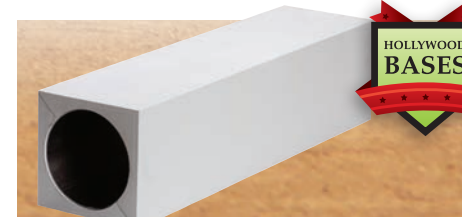

Pro Pitch

- High durability, molded rubber construction
 - Interior tube for maximum longevity
 - When filled with dirt or concrete, this is the most stable, rugged, 4-sided pitching rubber available
- 12909180

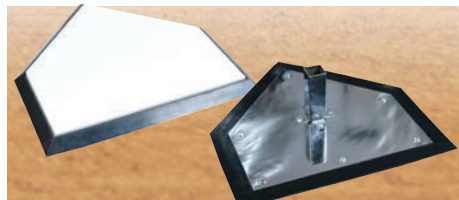

Pro Style Home Plate

- Official size, tough molded rubber with beveled black border
- Fits same ground anchor as the Pro Style Base Set and includes all hardware

PSHP

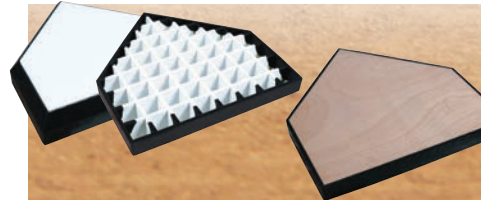

Home Plates

- Durable, all-rubber construction that can be buried for permanent installation
- UV resistant to avoid deterioration
- Available in waffle and wood construction

WAFFLE BOTTOM: PROHPW
WOOD BOTTOM: PROHP

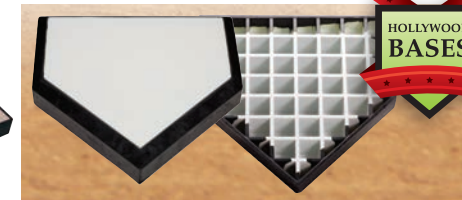

Hollywood Bury-All Home Plate

- High-durability, all-rubber construction
- No corners or edges to catch spikes
- Non-skid rubber surface

12908170

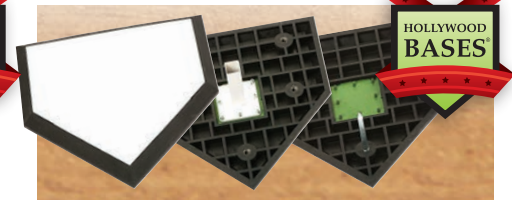

Universal Home Plate

- High-durability, suitable for portable or temporary install
- Includes 7" stanchion, 5 zinc plated spikes, 1 anchor and 1 plug
- 1 1/2" thick

12807300

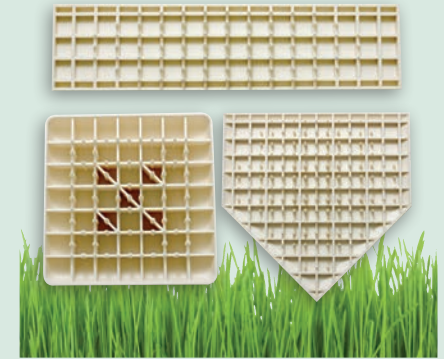

PlayersGoal Sports Equipment **TurfBase**®

- Designed specifically for synthetic turf
- No ground anchor necessary
- Easily installed and removed
- Durable all-rubber mesh reinforced construction
- Molded pegs grip turf and infill for superior hold
- Available in official size home plate and bases, pitching rubber, and double first base

BASES 15" X 15" X 3", SET OF 3: TB3
DOUBLE FIRST BASE SET: TBDFB
HOME PLATE, OFFICIAL SIZE: TBHP
PITCHING RUBBER - 6" X 24": TBPR

Baseball Accessories

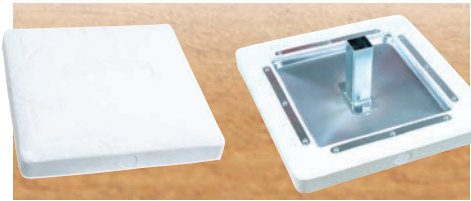

Pro Style Base Set

- Rust resistant, nickel-plated, triple-reinforced steel anchor system and stanchion pan with anchors and plugs
- UV resistant rubber prevents spike punctures
- 15" x 15" x 3"

PSS3



Pro Style Safety Base Set

- All-rubber design minimizes sliding injuries
- "Pillar" construction provides vertical stability and horizontal flexibility

PSS3

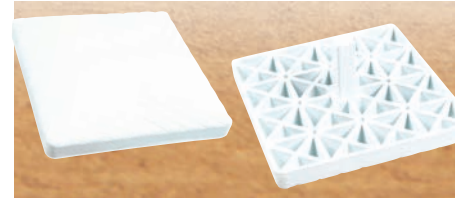

Low-Profile Pro Model Base Set

- Low profile pro model base
- Breakaway style, molded rubber base
- Set of 3, complete with anchors and plugs
- 15" x 15" x 2.5"

ES3

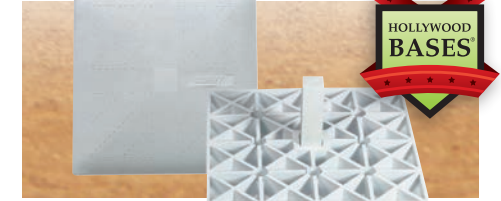

Impact Base

- Compresses upon impact
- Includes ground anchor
- 15" x 15" X 1 1/2"
- Set of three bases

12902010



Jack Corbett MLB Hollywood Base

- Comes with 6" stanchions
- USED BY MLB® SINCE 1939
- The exclusive base of MLB®
- Used by National Pro Fastpitch Softball clubs
- Anchor plugs & ground anchors available

12901010



Hollywood Double Impact Base

- Unique design compresses upon impact; one-piece molded base - will not separate
- Recommended for recreational and youth levels of play
- Dimensions: 30" x 15" x 2 1/2" / 4" stanchions

12902080

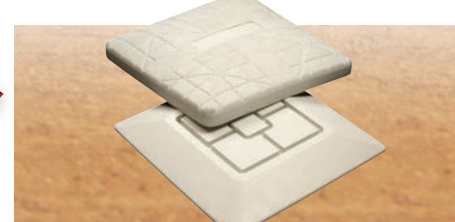

Breakaway Base Set

- Quick release base disengages from stationary rubber base plate upon impact.
- Easily installs in standard ground anchors.
- 15" x 15" x 2-1/4".

BBS

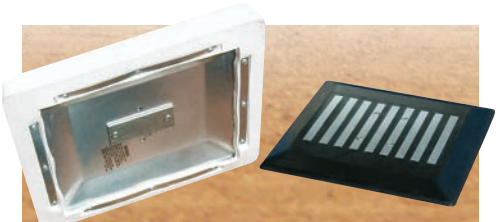

Magnetic Break Free Base

- Quick release base disengages from stationary rubber base plate upon impact.
- Easily installs in standard ground anchors.
- 15" x 15" x 2 1/4" Sold individually.

MBFB



Kwik-Release (Single)

- Kwik-Release Bases disengages from base upon impact
- Approved by Little League®
- Patented design compresses upon impact
- Easily Installs in 1 3/4" square ground anchors

VARSITY: 12906040; SET OF 3: 12906030;
YOUTH: 12906010

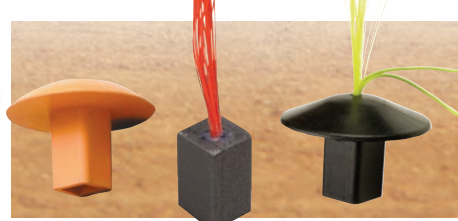

Base Plug Markers

- Close-fit design keeps plug from dislodging
- Available in highly visible optic orange color or with optic stem to indicate anchor position
- Withstands damage from infield rakes and tractors

ORANGE: PLUG; ANCHOR PLUGS W/INDICATOR: BAPF; BLACK W/OPTIC STEM: WAP



CH Base Anchor

- Heavy Duty 1-1/2"
- Available in Hollywood Red and Hollywood Galvanized Steel
- Also available for the 'Bolco System'

RED: ANCHORHHD; SILVER: ANCHORH



CH Base Anchor Starter System

- Base anchoring system requires no digging or concrete
- CH anchors will last 5-10 times longer than traditional ones
- Set includes 1 driver & 3 heavy-duty 1 1/2" W x 18" L anchors

CHSSH

Baseball Accessories



Base Runner Rake

The professional's choice... a field rake with a telescopic handle.

- Perfect tool for grooming infields
- High-grade aluminum alloy head was designed specifically for the sports turf industry
- High, straight edge is excellent for grading, while the rounded teeth are non-gouging
- Double lock telescopic handle easily adjusts from 39" to 70"

12503



Field Rake

Engineered to the specifications of professional baseball grounds crews.

- Extended grading edge designed specifically for leveling
- Rounded teeth for smooth non-gouging raking action
- 66" powder-coated aluminum handle with wrap-around bracing

GM584



Chisel-Tooth Rake

The aggressive chisel-sharp teeth and forward grading edge set this rake apart from the others

- Perfect for penetrating and breaking up hard soils
- Extra-thick teeth hold up to extremely heavy use
- 66" powder-coated aluminum handle and 6" vinyl grip provide maximum comfort

GM576



Pro Turf Lute

This lightweight, heavy-duty lute combines an engineered head design with strong wrap-around bracing and is perfect for spreading gravel or for grading soil.

- Solid aluminum plug in the head-to-handle connection
- Comes with an 82" powder-coated aluminum handle

GM583



7' Double Play

Monster Broom

- 7' wide bristles
- 7' head with A-frame handle
- 3 rows of replaceable 3-1/2" bristles
- Foam padded handle with hooks for storage
- Short teeth for breaking up hard, dry clay
- Bristle side used for finishing

DB7DP



Toolite® Sifting Scoop

Remove debris when top-dressing athletic fields and diamonds.

- Great for screening and sifting rocks and unwanted material during pre-seeding
- 14" x 17" scoop style head with 27" D-grip handle

SFTSHVL



Toolite® Sifting Shovel

Perfect tool for sifting and removing debris when top-dressing athletic fields and diamonds.

- Heavy-duty, lightweight construction
- Strategically placed holes allow for maximum sifting action

GM589



Loop Hoe

Makes light work of regular maintenance on the field.

- Double knife edge rocks back and forth with a push/pull motion.
- Excellent for cultivating, aerating and weeding. The blade is also replaceable

HOE



Mud Strainer Attachment (sold separately)

Field Pump

- Made of high impact PVC
- Non-Sparking
- Will Not Rust
- Self Priming
- Removable Foot
- For non-potable water only
- Includes a 6' hose.

GM590, GM590S (Mud Strainer Attachment)



Tamper

- Welded all-steel head construction
- 1/4" thick base plate
- 1-1/2" diameter, 48"L handle available in steel or fiberglass
- Available in 8"x8" and 10"x10"

8"x8":
TAMP8 (steel handle), TAMP8F (fiberglass handle);
10"x10":
TAMP10 (steel handle), TAMP10F (fiberglass handle)

Baseball Accessories



Shown here with optional Drag Mat (See 'B').

A Pro Groomer™

Restore and maintain infields quickly and easily. Levels, smoothens, mixes and breaks up hard infields.

- Cuts off high spots, mixes and carries the material along, then drops it into low areas where it's needed
- Reduces sliding injuries, water puddling problems, weeds and more
- Available in either manual or electric lift
- Easily adjusts to different towing machines
- No need for hydraulics or 3 pt. hitch
- Saves on labor costs
- Heavy-duty steel construction
- Powder coated finish
- Use on a variety of granular surfaces
- Optional drag mat available (Item: AS58-m, See 'B')

PR72-E



B Drag Mats

- Smooths rough, upturned infield dirt between innings and games
- Tough, flex steel construction
- Includes pull rope and comfortable, wooden handle

3' x 5' - BS890, 6' x 6' - BS891.
OTHER SIZES AVAILABLE



C

C All Star Chisel-Drage™

Pulverize aeration cores on greens, incorporate top dressings, brush/groom greens, de-thatch, aerate, groom baseball and softball infields, groom artificial turf and more.

- Grades, mixes, and smoothens
- Breaks up hard infields
- Save on labor costs
- Reduces sliding injuries, water puddling problems, weeds and more
- Helps control weeds
- Easily adjusts to different towing machines
- Heavy-duty steel construction
- Powder coated finish
- Use on a variety of granular surfaces

AS72-M

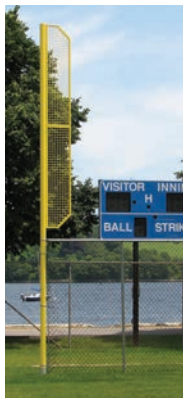

PlayersGoal® Sports Equipment

Foul Pole

- Powder coated yellow
- Manufactured from 4" or 6" aluminum pipe and available in standard above ground heights of 15', 20', 30', and 40'
- Utilizes ground sleeves with corresponding caps or a base plate mounting system for a semi-permanent install



Batting Tunnel

- All standard batting tunnels come with a black #36 nylon 1-3/4" square mesh net with entrance/exit, block pulley system, corresponding ground sleeves with caps and net extension arms to ensure the net remains taught and secured to the ground
- Available in both a cantilever and overhead style

Baseball Accessories



RED Infield Conditioner

No other conditioner in the industry has higher absorption rates or lasts longer on your field.

- Provides maximum drainage of rainwater on your athletic fields
- Creates a capillary system which absorbs large amounts of water quickly
- The heat treated particles won't blow away in heavy wind
- Reduces field costs dramatically by providing years of performance

PREP50

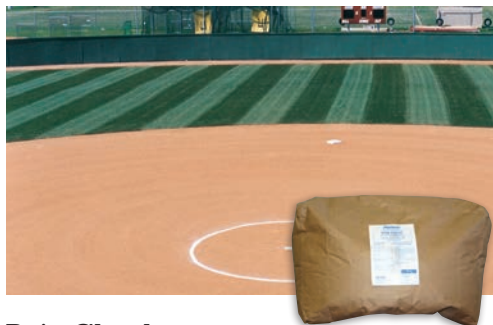

Rain Check

- Turn muddy, soft ground into a firm, stable surface
- Absorbs 500% more water than clay
- 80% less labor and storage requirements
- Blends into your field, leaving no detectable residue
- Biodegradable, all-natural ingredients

RAIN40



Rapid Dry Drying Agent

These tiny granules are designed to quickly wick away excess water from your infield and keep your games playing safely and without delay.

- Specifically designed to absorb infield puddles
- Small, baked granular particles that increase absorption and insure durability, providing firm footing
- Improves soil consistency and helps reduce compaction
- Won't cake, harden or become slippery

QUICK50



RainOut

- Non-toxic field conditioner you can use before or after it rains
- Draws standing water and breaks up clumps of mud providing a smooth game-ready infield
- Improves drainage and absorption for great performance and minimal field damage

RAINOUT



A Mound Bricks

- Easy to install
- Extremely durable
- 312 bricks per pallet
- Provides great stability and performance for pitchers mounds and batter's boxes
- Bricks made of dark brown clay

MB312



B Mound Clay

- Eliminates problems by providing excellent footing for players
- Outstanding durability from high-performance clay reduces field maintenance
- Easy to install
- Great for repairs to troubled areas
- Dark brown color

MC40 (Dark Brown); MC40 (Fine Texture, Red-Brown Color); MC50PC (Unique Blue Gumbo Clay)



C Mound Slope Gauge

- Makes building and maintaining your baseball mound simple
- Alignment gauge made of one-piece, heavy-duty aluminum
- Bubble level (included) attaches for proper leveling
- Includes metal ruler for measuring mound slope drops
- Two support rods included, one of which is adjustable for leveling the gauge

MSG

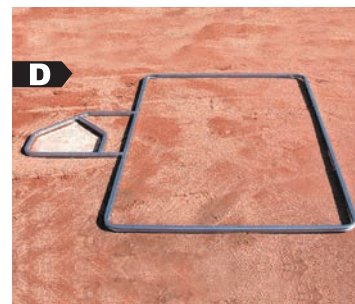

D Batters Box Template

- Made of 1" square galvanized steel
- Adjustable for 3' x 6' (youth league), 3' x 7' (softball), and 4' x 7' (official baseball)
- Line up markers ensure proper positioning on either side of home plate
- Other styles available, including aluminum templates

BBT3WAY

Baseball Accessories



Color Guard™ Fence Covers

Enhance the appearance of your field and the safety of your players.

- Covers the sharp edges of chain-link fences to help protect players
- 6 UV resistant colors to match your team
- Pre-drilled every 24" and includes ties
- Available in two grades, premium (4 UV resistant colors available) and standard (6 UV resistant colors available), to meet the needs of every budget



Enduro Fencing

- 4' high fencing with vinyl pockets for poles
- Soft poly mesh with vinyl pockets sewn on at 10' intervals (approximately)
- Yellow home run marker on top edge
- Available in green, red and blue
- Enduro fencing is available in kits



Boundary Netting

- Extruded thread with built-in UV treatment, weather protection and Black color
- Weatherproof, mold and mildew resistant
- Available in Economy, Standard, and Premium netting grades



Outfield Distance Markers

- Constructed of 13 oz. reinforced vinyl fabric
- Available with numbers and background colors of your choice



Safety Foam

Covers fence tops, rails, posts and poles

- Custom solutions for your facility
- Available in 15 colors
- Standard and custom sizes available



Fence Topper

- 4-1/2" diameter tubing reduces the possibility of injury from chain-link fencing
- Heavy-duty polyethylene
- Pre-slit for easy installation with the Fence Topper Installation Tool (photo inset)
- Available in 100' and 250' coils, in black, yellow, or dark green



Grand Slam Fencing

- Durable yet soft, and easy-to-handle
- Quick and easy to set up and take down
- Available in red, blue, and green, all with yellow top home run marker
- Standard: poles at 10'; Optional: poles at 5' to minimize sagging
- 4' or 5' heights (5' in green only)
- New synthetic turf version now available

GRAND SLAM FENCING™ IS EASY TO SET UP AND TAKE DOWN

1. Insert poles through 3 loops woven into fence fabric.
2. Attach fence fabric to top cap with easy open/close latch.
3. Mark and drill holes for poles with 10" auger (included).
4. Place poles and sockets into holes. Fence is ready for use!
5. When you take down the fence, roll up with poles in place. Only takes minutes

Available in three kits:

- **Softball and Little League Kit** 200' home run distance (314' one piece fencing kit)
- **Baseball and Men's Softball Kit** 300' home run distance. (471' one piece fencing kit)
- **Custom Kit** Simply provide your HR distance for a quote



Softball and Little League Kit



Baseball and Men's Softball Kit

Football Accessories

A Dial-A-Down®

- Down box with slide levers and large, highly visible numerals
- Foam padding on head and 2-piece pole for increased safety
- Waterproof and weather resistant (won't bleach out)

DDOWN

B Down Indicator

- Easy flip numbers secured with grommets and rings
- High visibility, 2-color numerals
- Completely padded for increased safety

DOWNI

C Chain Set

- Plated chain and swivel hooks eliminate kinks and knots
- Bright colored targets are completely padded

CSET

D SoftSwipe®

- Durable 12" rubber molded disk
- Simply drop disk and swipe mud and debris from cleats
- Restores traction giving your players the competitive edge and safety they deserve

SWIPE

E Chain Gang Vests

- Elastic waist sides with Velcro on one side
- Slip-over design in yellow and black with black neck trim
- Set includes 2 striped vests and 1 diamond vest

L156733

F Yardline Markers

- Durable, 2-sided, highly visible markers
- Weighted, no need for anchors
- Side strap for easy carrying
- Available in standard and deluxe versions

Standard: YLM11; Deluxe: YLM11D

G Goal Line Pylon

- Mark all 4 corners of the end zones, with 2 extra pylons for the back of the end zone to help receivers see the end line
- Weighted to eliminate the need for post holes and anchors
- Durable solid pylon stands straight and highly visible

Premium 6 / Set (Solid) - GOAL6D
Standard 4 / Set (Vinyl Wrapped) - GOAL4



A



B



C

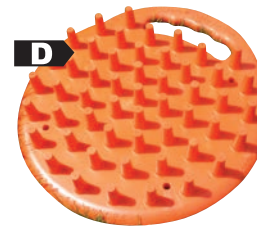

D



E



F



G

Football Accessories

A Goal Post Pads

Customize the look of your goal posts while increasing the safety of your players.

- Polyfoam core helps protect players from injuries resulting from impact with poles
- Pads come in pairs and are available in either 13" or 18" diameter
- Two styles of pads; Velcro closure and enclosed
- Custom lettering and logos available
- Meets NCAA and NFHS safety standards

Goal Post Pad Styles:

Velcro: A foam cylinder under a vinyl cover is closed with Velcro strips along the length of the pad. Designed like the pads used in pro football. Available in 6', 7', and 8' heights.

Enclosed Pad: Foam core is completely encased in vinyl to protect core from the deteriorating effects of weather and moisture. This feature extends the life of the pad and cuts down on installation time. Available in 6', 7', and 8' heights.



B Goal Post Paint

- Highly visible, DayGlo® super-bright fluorescent paint with a clean, semi-gloss finish
- Available in 1-gallon pails of Saturn Yellow or Blaze Orange Orange - D215151, Yellow - D215171

C Goal Post Streamers

- Help your kicking game with a set of four wind direction streamers
- Standard style is made of 18 oz. single-ply vinyl with grommets at end for attachment with a zip-tie. Available in rocket red
- Deluxe style is made of double-ply 18 oz. vinyl with heavy-duty hook at end for attachment to goal post. Super bright Rocket Red color is highly visible in all conditions. (shown as left)

Standard - GPS4, Deluxe - GPS4D

D Goal Post Paint and Streamer Kit

- 2 1-gallon pails of Waterborne Acrylic Primer
- 2 1-gallon pails of DayGlo® super-brite fluorescent paint with a clean, semi-gloss finish
- 4 orange goal post streamers

GPK

E Filteray® Goal Post Overcoat

- Improves weatherability and lightfastness of your goal post paint
- Clear overcoat which filters out the harmful rays of the sun to prolong finish and color of goal posts
- Provides an easy-to-clean, semi-gloss finish

FILTD1



Football Accessories

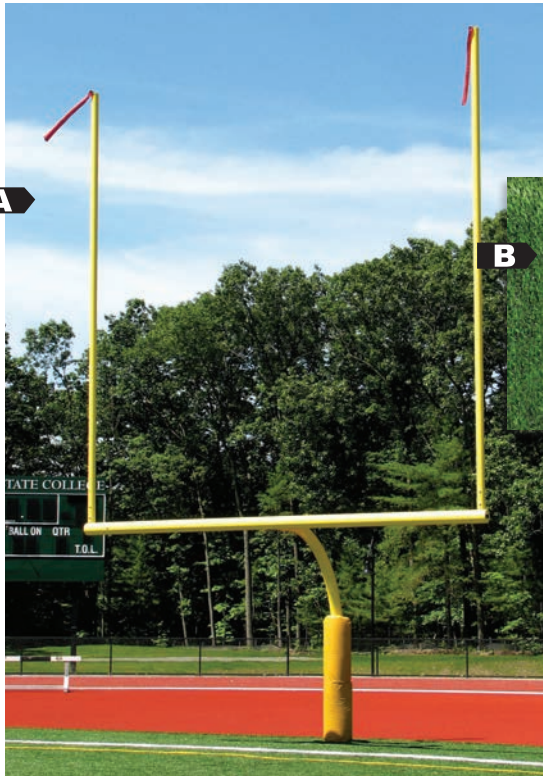

A

PlayersGoal®
Sports Equipment



B

A Advantage XI® Field Goal

- The Advantage XI® football goal posts are heavy duty, all aluminum single support, 6' or 8' offset gooseneck designs.
- Ground sleeve or base plate mounting
- Available with either college/pro crossbar (18'6" wide), high school crossbar (23'4" wide) or expandable
- Available in yellow or white powder coated finish
- Choose from 20' uprights (standard) or 30' uprights
- To meet the increasing demand for versatility in multi-use athletic fields an expandable college/high school crossbar is also available
- Easily removed or adjusted when installed in conjunction with our access frame kit option

B Advantage XI® Football Goal Post Access Kit

- The access kit allows for ground sleeve based goal posts to be installed and removed quickly and easily
- Inset design conceals the locking bolts used to anchor the goal post into the ground sleeve
- Natural Grass Application or Synthetic Turf Application covers the access kits included



Equipment Cart

- 500 lbs. capacity
- All-aluminum and powder coated construction
- 3' x 5' rubberized, coated deck
- Can be manually pulled or hitched to a utility vehicle

30B0507

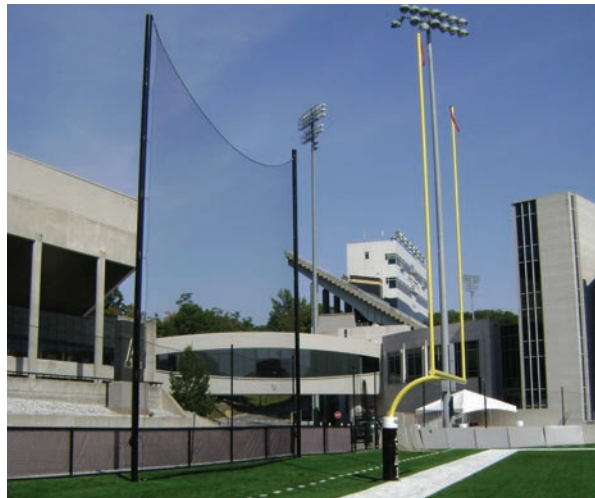

Football Netting System

- Two 6" poles
- Two 60" ground sleeves
- Hardware kit and cabling
- 4" square mesh rope bound black nylon net
- 3 systems available: 30'H x 40'W, 40'H x 40'W, & 40'H x 40'W Stormguard® break-away

PGFNS

PlayersGoal®
Sports Equipment



Combination Football/Soccer Goal

- All-aluminum construction including ground sleeves with caps
- Kwik Lock® net system
- Soccer backstays
- Detachable 2" round x 15' uprights
- Semi-permanent
- Power coated white
- Soccer goal: 8'H x 24'W x 3'D x 8"B
- Football goal: 10'H x 23'4"W

2D301

Football Accessories



FieldSaver® Weighted Track Protector

PREMIUM

- Easy to install and remove
- Available in 12 oz., 16 oz. and a variety of sizes to fit your facilities requirements and budget
- Custom logos and 42" lettering available
- Gray blanket color designed to reflect heat
- Hemmed, weighted vinyl binding lies flat, stays in place, and is available in 14 colors

WCT



ArmorMesh Sideline Turf Protector

PREMIUM

- Heavy-duty woven mesh (14 oz.)
- Extrusion coated yarns
- Better than dip-coated mesh products
- Excellent tear and burst strength properties
- Allows air and water passage
- Does not absorb water
- 12 stock colors available
- Customize with logos and lettering
- Available in a variety of sizes - call for details
- Comes with a 5-year pro-rated warranty

SLTAM



Rollout Track Runway

STANDARD

- Protect your track and runways
- Installs in minutes
- 3/8" heavy-duty black rubber stands up to the heaviest foot and cleat traffic
- Rolls up for easy transport and storage

Available in 36", 48" and 60" widths
RTPB1



Blanket Sideline Tarp

STANDARD

- Non-woven polypropylene
- Breathable to allow water and air passage
- Helps eliminate damage to grass from cleated shoes
- Covers bench area, between the 25 yard lines
- Heather Gray to reflect heat
- New and improved - now heat-treated on both sides offering maximum durability
- Customize with lettering and logos
- 12 oz. - 2-year warranty
- 16 oz. - 3-year warranty



Shown Here: ArmorMesh Sideline Turf Protector

Soccer Accessories



A Elite Team Shelter I

- Available in 9', 15', and 24' lengths
- Smoke colored Lexan® polycarbonate panels
- Aluminum bench with back
- Equipment storage shelf behind bench
- 4 semi-permanent ground anchors

9B1001



D Portable Auger Anchors

- Set of 4 anchors secures 1 goal
- Used for portable outdoor installation
- Designed for soft or sandy soil

S10B1101



E Steel Anchor Weights

- Set of 2, with chain for convenience
- Used for portable indoor/outdoor installation
- Carry bag contains 40 lbs. of steel weights

10B1605



B Portable Shade Shelter

- Soft-top and hard-top versions available
- 6-1/2" H x 15' W
- 10' W aluminum bench and back
- All-aluminum frame
- Powder coated
- 6 "no flat tire" swivel wheels

9B1801

Find our full line of soccer products at: pioneerathletics.com



F Universal Corner Flag/Marker

- Comes in a set of 4, 60"H x 1" round uprights, with yellow hollow bases (must be filled with sand). Ideal for turf, indoor, and outdoor use

SCFW4 (Single);
6B1104 (Set of 4)



G Official Corner Flag/Marker

- Comes in sets of 4, 16, and 32, 60"H x 1" round uprights, and a round steel base with ground peg
- Red or Pink flags available

6B504



H Obstacle Flag/Marker

- Sold in sets of 4, these 60"H x 1/2" round Lexan® uprights can serve as a corner flag or obstacle marker

• Red, Blue, and Yellow flags available
6B404 (Set of 4)



C Saddle Anchor Bag

- Straddles bottom bar of goal for secure, clean fit
- Bag top openings allow for continuous net attachment
- Plastic center strip for additional support
- Reinforced stitching and zipper
- Stainless steel clasp and "D" ring
- Fill with up to 40 lbs. of sand or stone (not included)
- Used for portable indoor/outdoor installation

10B1605 (Single); 10B3606 (Set of 6)



Wheel-to-Wheel Line Painter

- Simple and durable liquid transfer line painter
- Paint transfers from 15 liter (3.96 gal.) hopper to a 4" wide marking wheel
- Creates even and accurate lines
- Adjustable, steel-tube handles and pneumatic tires for any terrain
- Designed for shorter grass surfaces

W2W



GameDay® Wheel-to-Wheel

- A variation of our premium Game Day field marking paint
- Specifically designed for wheel-to-wheel line marking machines
- Ready-to-use formula — no dilution necessary
- Popular on soccer pitches, rugby fields, and grass tennis courts



Fair Play Vanishing Foam Spray

- Vanishing foam spray used by referees
- Effectively establishes the 9.15 meter barrier required between defenders and the ball during free kicks
- Minimizes game delays caused by violations of this space
- Optional can holder sold separately

Foam Spray: 95; Can Holder: 95H

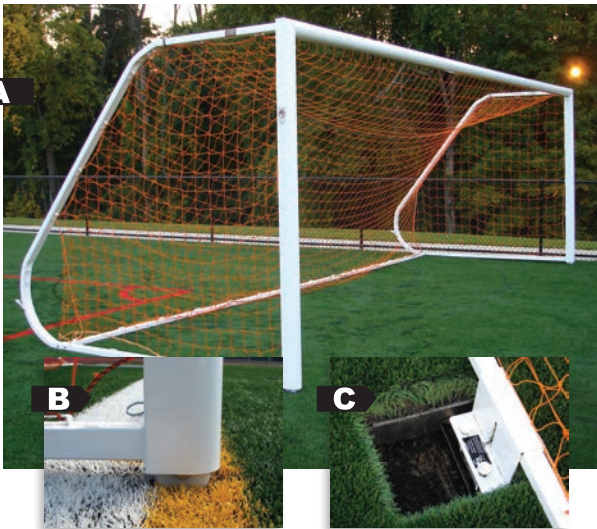

PlayersGoal® Sports Equipment

A Advantage XI® Soccer Goal

- The Advantage XI® aluminum square post and round faced soccer goals are designed with the end user in mind
- Built with high strength TIG welded aluminum
- Powder coated white finish ensures premium protection from the elements for years of competition
- Unlike other soccer goals, the Advantage XI goals utilize a one-piece back ground bar and unique welded in place net attachment system, eliminating complicated loops, vinyl strips or plastic parts to be lost and replaced and it's guaranteed for the life of the goal

PlayersGoal® Sports Equipment

B Advantage XI® Mobility Kit

- The Advantage XI integrated on-board mobility kit eliminates both add-on wheels that are easily misplaced, and permanent side-mounted wheels that can be dangerous and in the way of play
- Eliminates unnecessary add-on components ensuring safer movement of the goal

PlayersGoal® Sports Equipment

C Advantage XI® Safety System

- Provides for safer play by providing a permanent anchoring system which blends into the field when not in use
- A below ground, self storing, rotating clamp/bracket firmly grabs the back bar of the soccer goal ensuring that the goal remains firmly planted to the ground

Soccer Goals

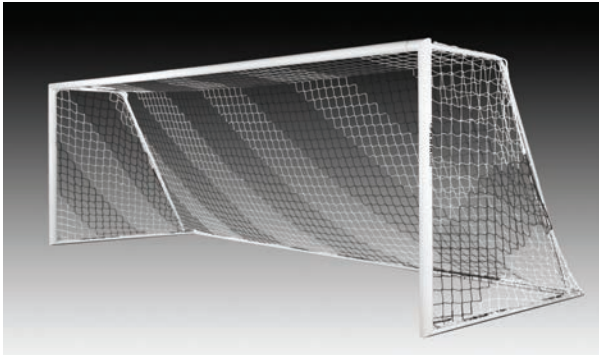

Evolution® Goals

- 4 sizes available
- All-aluminum construction
- Elliptical base and back bottom bar
- 2" round tube backdrop
- Evolution net system: runs throughout goal and allows for easy net attachment
- Powder coated white

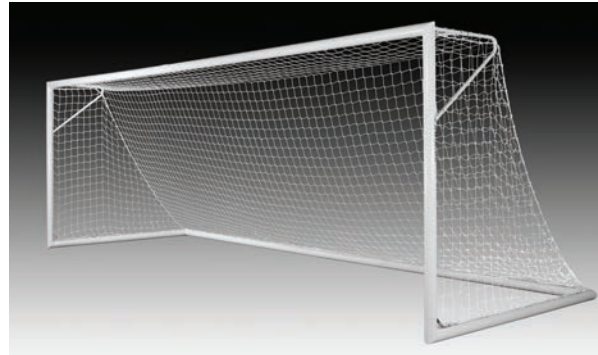

Fusion® Goals

- 3 sizes available
- 4" round tube throughout entire goal
- All-aluminum construction
- European backstays
- Kwik Lock® net system
- Semi-permanent and portable
- Powder coated white

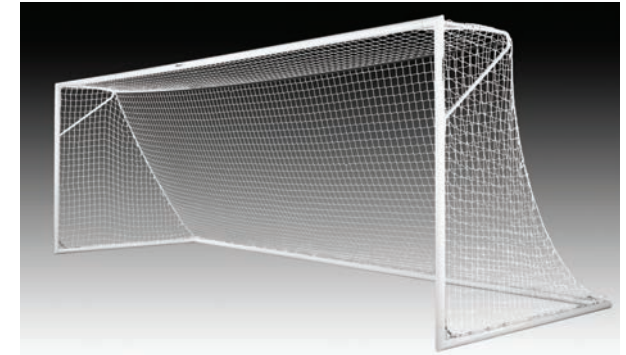

Deluxe European® Goals

- 6 sizes available
- 3" round tube throughout entire goal
- All-aluminum construction
- European backstays
- Powder coated white

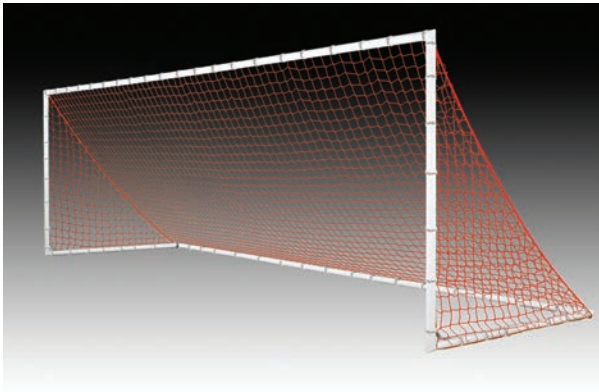

Academy® Goals

- 6 sizes available
- 3" round tube throughout entire goal
- Lightweight tubes for portability
- All-aluminum construction
- Powder coated white



Infinity® Goals

- Steel/poly frame
- Weighted and non-weighted options available
- Elastic anchor tethers
- 15mm polyester mesh net
- Comes with carry bag

San Diego Jewish Academy
San Diego, California

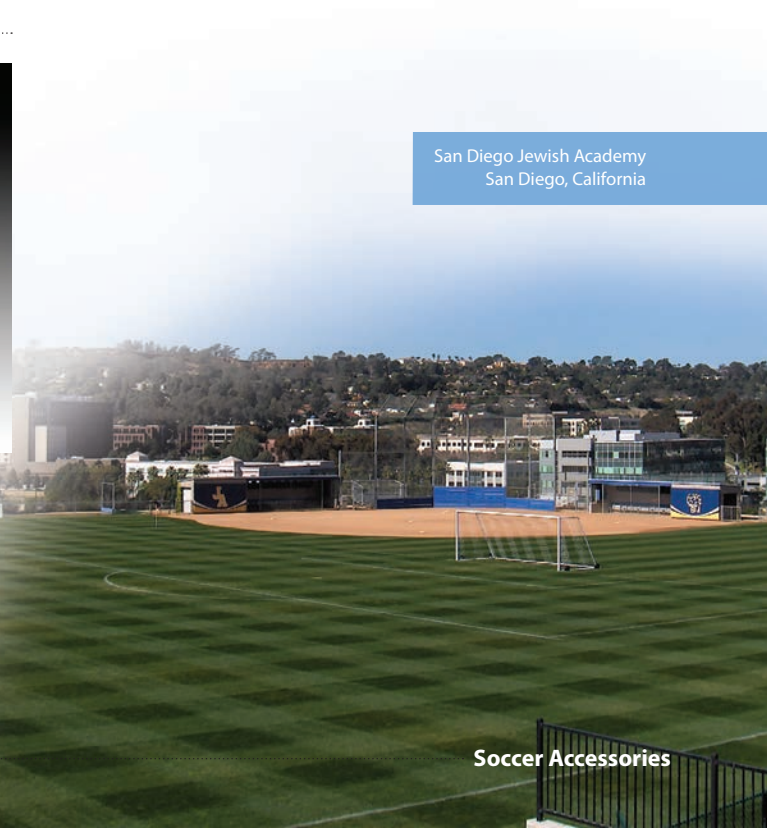

Soccer Net Accessories

To find your net size, measure the Height, Width, Base, and Depth. See illustration below for guidance

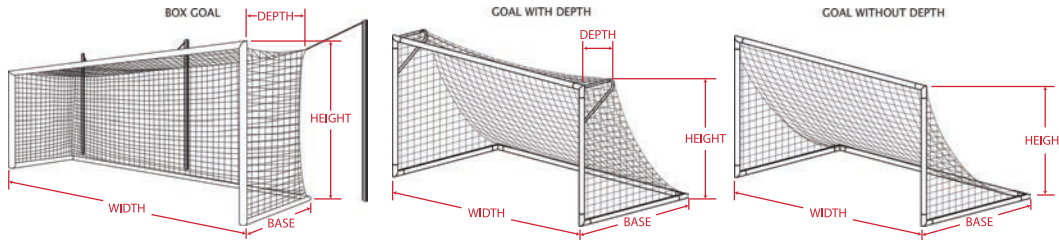

Kwik Goal® Nets

- Material: high tenacity polypropylene
- Rope type: solid braid, knotless
- 36 different sizes available. Visit us online to see all available sizes
- Contact us to find the right net for you

Call us at 800-877-1500 or visit us at: pioneerathletics.com for more!

KWIKGOAL

Ask about our full line of KWIKGOAL products for soccer, lacrosse, and field hockey.

Visit us online at: pioneerathletics.com/downloads to download our complete catalog of soccer goals, nets, accessories and other field equipment.



Net Attachment Clips

- 24 "S" clips per pack
 - Fits goals with net rail systems
 - 4 packs attach 1 net to 8' x 24' goal
- 10B304



Net Fastener

- 12"L x 1"W
 - Reusable, 2-sided Velcro®
 - 2 rolls attach one net to an 8' x 24' goal
- MNF-1



Kwik Lock® Net Clips

- 50 clips per package
 - Goals with Kwik Lock® & Evolution® net systems
 - 2 packs attach 1 net to an 8' x 24' goal
- 10B3201

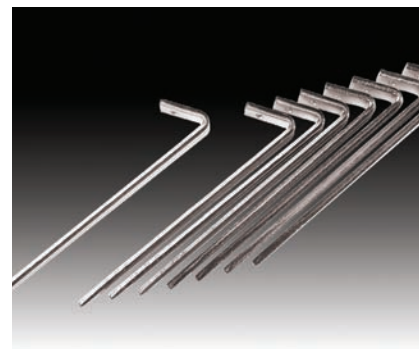

Net Pegs

- 8" steel pegs
 - Set of 8 per pack
 - 1 set secures two 8' x 24' goal nets
- NP-2



Bungee Net Fastener

- Pack of 30; 3 packs attach 1 net to 8' x 24' goal
 - 1/4" black elastic & UV resistant cord
 - Attaches net on goals with up to 3" round post
- 10B3501

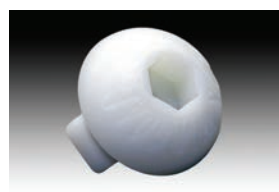

Tamper Resistant Net Clips

- 100 pilfer-resistant clips per pack, driver included
 - Fits goals with Kwik Lock® and Evolution® Nets
 - 1 pack attaches 1 net to 8' x 24' goal
- 10B3401

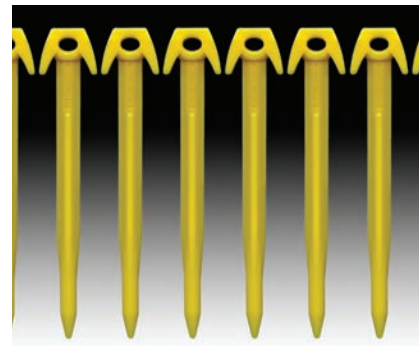

Nylon Pegs

- 6" nylon pegs
 - Set of 6 pegs per pack
 - 1/4" hold for tying ropes
 - Used for securing nets and Infinity® goals to natural grass fields
 - Features hooks for securing looped end ropes
- 10B1301

Bleachers and Benches

Many lengths available for all bleacher styles.

A 3 Row Standard Bleachers

STANDARD Guardrail and risers not required by most building and safety codes.

- 16" first seat height
- 6" rise, 24" run per row
- Top seat under 30" high
- 2x10" aluminum seat plank
- Single (1) 2x10" aluminum foot plank



B 5-10 Row Standard Bleachers

STANDARD

- 17" first seat height
- 8" rise, 24" run per row
- 2x10" anodized aluminum seats
- Chain link guardrail included (Optional vertical picket guardrail available)
- Single (1) 2x10" aluminum foot plank under seat rows 2 and 3
- Double (2) 2x10" aluminum foot plank under seat rows 4 and up
- 1x6" riser plank under seat row 4 and up
- 2x10" riser plank below top row



C 3-10 Row Preferred Bleachers

PREFERRED Our Preferred models include all the features of our Standard models, plus:

- Double (2) 2x10" foot planks on all rows



D 3-15 Row Deluxe Bleachers

DELUXE Our Deluxe models include all the features of our Preferred models, plus:

- Aisles with handrails
- Riser planks on all rows



Powder Coated Seat Plank Colors:



All Non-Elevated bleachers are available with either galvanized steel or aluminum angle frames

Also ask us about:

E Tip N' Roll Bleachers

Our Tip N' Roll bleacher is easily tipped up onto its swivel casters for movement and storage when not in use.

F Low-Rise Bleachers

First seat under 12" high. 3 and 4 row Low Rise bleachers are also available as Tip N' Roll or Transportable bleachers.

G Transportable Bleachers

Each Transportable bleacher is fitted with a galvanized steel horizontal lifting brace, and extra bracing to stabilize bleacher when transported.

H Elevated Bleachers

For events and venues where elevated bleachers provide better viewing for your spectators.



All bleachers should be anchored to resist wind loads. Please contact your local code authority for compliance with applicable codes.

Bleachers and Benches

All benches are available as either portable or permanent, with or without backrest, with either aluminum or galvanized steel legs. Available in 6', 8', 12', 15', 21', and 24' lengths.

Powder Coated Seat and/or Backrest Colors:



“DE” Locker Room Bench without Back

- Aluminum seat, aluminum legs
- Shown with optional rubber foot pads



“PI” Portable Bench without Back

- Aluminum seat with galvanized steel legs



“PE” Surface Mount Bench without Back

- Aluminum seat with galvanized steel legs



“PG” Portable Bench with Back

- Aluminum seat with galvanized steel legs



“DGS” Portable Bench with Backrest & Shelf

- Aluminum seat, aluminum legs

Replacement Seating

Many old or unsafe bleachers can be retrofitted using the existing framework by adding aluminum planking to replace deteriorated wood planks and to close up unsafe gaps.

No more looking for broken or weak wooden planks when you renovate with low-maintenance aluminum.

We offer expert assistance in planning your renovation, and have a variety of aluminum plank profiles which can provide solid adaptation to most existing structures.

Update your old, unsafe bleachers to comply with today's building and safety codes.



If your old bleachers look like this...



We can make them look like this...

Custom and Standard Windscreens

Tuffy® Windscreen **PREMIUM**

| | |
|---------------------|---|
| Product | Tuffy® |
| Style | Open mesh, 10 oz., brass grommets every 12" |
| Colors | Beige, Black, Brown, Burnt Orange, Gold, Gray, Maroon, Medium Green, Midnight Green, Navy, Orange, Purple, Red, Royal Blue, Scarlet, Sky Blue, True Yellow, Vegas Gold, White |
| Shade Factor | 78% |
| Warranty | 5 Year Limited |

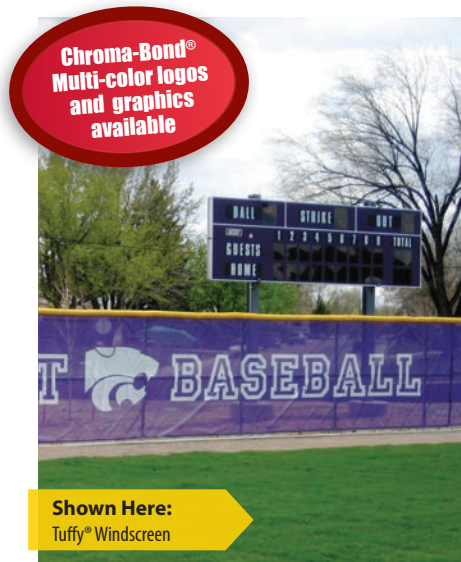

ArmorMesh Windscreen **PREMIUM**

| | |
|---------------------|---|
| Product | ArmorMesh |
| Style | Open mesh, 14 oz., brass grommets every 18" |
| Colors | Black, Carolina Blue, Dark Green, Kelly Green, Light Gray, Maroon, Navy Blue, Orange, Purple, Red, Royal Blue, Yellow |
| Shade Factor | 75% |
| Warranty | 5 Year Limited |

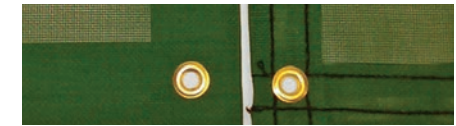

ArmorMesh Incredisail™

- Comes standard on ArmorMesh Windscreens
- All sewing and stitching eliminated providing a 'Clean' look - no pleats, no black webbing on hem, no stitches
- Web reinforcement is inside the 3-ply heat bonded hem

Windscreens come in standard and custom sizes, with the following options:

- Anti-billow tabs – grommet strip in center to increase durability. Visible on back side only. (available on 9' height only)
- Boxed Windows – recommended for 7' tall or higher
- ½ Moon die cut vents (18" semi-circle) for visibility and wind passage
- Rope-cord
- Break away tie-wraps
- Snap hooks
- Logos, numerals, text
- Made of vinyl coated polyester
- Available in 6' and 9' heights

| Product | PVC70 | PVC85 | PVC95 | Royale Open | Royale Closed |
|---------------------|---|--|---------------------|---------------------------------|---------------------|
| Style | Open mesh, 8.2 oz. | Open mesh, 9 oz. | Closed mesh, 19 oz. | Open mesh, 16 oz. | Closed mesh, 11 oz. |
| Colors | Black, Brown, Carolina Blue, Forest Green, Gray, Kelly Green, Maroon, Navy Blue, Orange, Purple, Royal Blue, Tan, White, Yellow | Black, Forest Green, Navy Blue, Royal Blue | Black, Forest Green | Black, Forest Green, Royal Blue | Black, Forest Green |
| Shade Factor | 84% | 80% | 85% | 80% | 95% |
| Warranty | 2 Year Limited | 2 Year Limited | 2 Year Limited | 3 Year Limited | 3 Year Limited |

Windscreen Colors*:

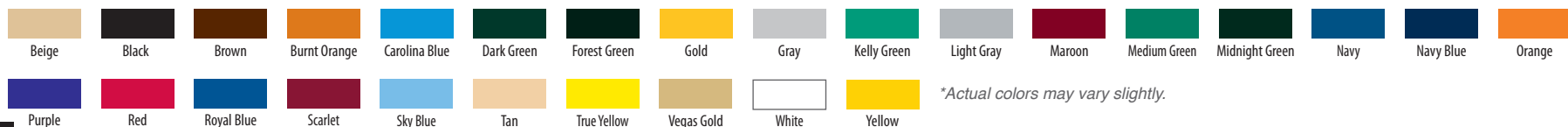

*Actual colors may vary slightly.

Protective Padding

A Protective Padding

Create excitement in your gym. Here's your opportunity to display your school pride while improving the safety of the players by absorbing impact. Our wall pads don't need special treatment, they can cover all types of wall surfaces including tile, brick and block and can easily be installed on walls, windows, doors and auditorium stages.

Applications:

- Gymnasiums, wrestling rooms, auditoriums, activity centers, baseball fencing, stadiums, recreation rooms, and multi-purpose rooms

Materials:

- 2" Polyfoam: Offers standard protection at an economical price. Available on all pads
- 1-1/4" Ethafoam: offers superior protection and durability. Available on all pads
- 2" Flame Retardant Polyfoam: Polyfoam with a flame retardant coating. Available on permanent pads only
- 2" Bond Foam available (interior applications only)



A



Wallpad Colors:



B Banners

- Quality 4-color digital print
- Available on polyester (63" x any length), vinyl (72" x any length), or windscreen vinyl (72" x any length)
- Sewn-in, reinforced hems with grommets and washers for extra support
- 3-year no-fade guarantee

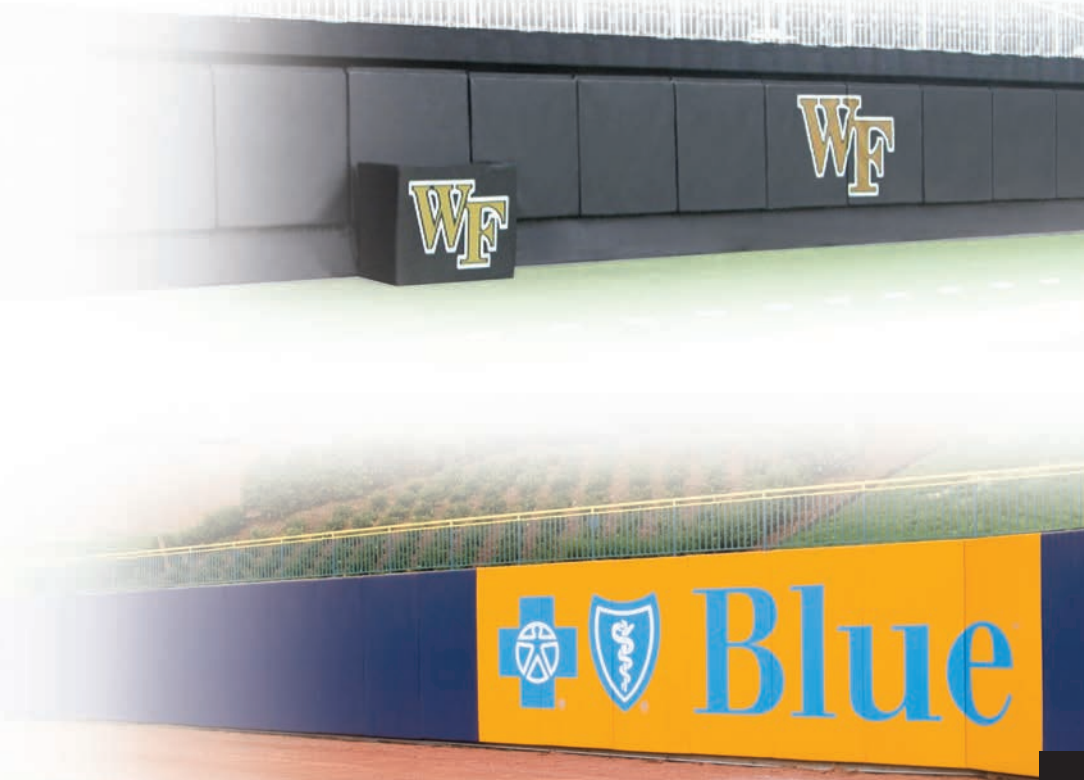

Wrestling Mats and Accessories



Wrestling Corner Mats

- 100% cut pile nylon for durability and wear resistance
- Scotchguard™ treated for stain prevention and easy clean-up and bound on all sides
- 5/16" 100% soybean pad attached directly at the mill
- Comes in 7'-6" rugs for regulation sized mats and 6' rugs for smaller sized mats
- Satisfies Coaches Restricted Zone (Rule 2-2-2), the 2008-09 rule change that clarified the existence of a boundary for the coaches' restricted zone on the corner of wrestling mat.
- Rugs come in sets of 2 - 1 red and 1 green rug
- Available with or without 'walk-off' mat
- Custom logos options available

7'6" - WCM7, 6' - WCM6

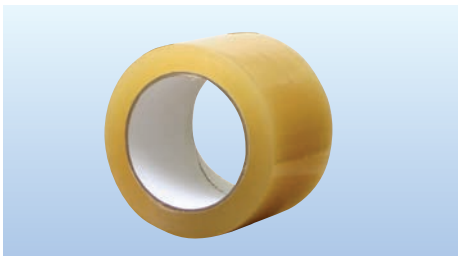

Wrestling Mat Tape

- Use to connect wrestling mats together
 - Clear in color once applied
 - Available in 3" or 4" widths
- 3" - WTape3, 4" - WTape4



Bucketless Mop

- Lightweight and easy to use self-contained mopping system
- A generous 52 oz. solution tank with an aggressive microfiber cleaning head means less time refilling
- Cleans up to 7,000 square feet per tank
- Comes with 2 replacement microfiber heads (also sold individually)

BM24KIT

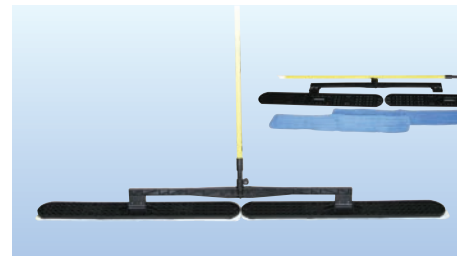

72" Large Microfiber Mop

- Disinfect and clean your wrestling mats
- Easy attach Velcro pads
- Kit includes: Microfiber Mop 72" (Frame and Handle and 3 - Microfiber 72" mop heads MF72KR; MF36R (Microfiber Mop Head Refill))



GymGuard® Floor Covers

Add years to the life of your gym floor!

Most gyms are multi-purpose so your gym floor has to hold up to a lot more than sports - dances, concerts, graduations, and other activities. It gets heavy foot traffic, stains, scuffs, impact from furniture and more. GymGuard® covers are built tough to protect your investment.

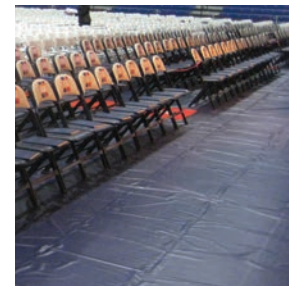

- Ultra-durable, 3 ply fabrics - PVC coated (on both sides) polyester mesh.
- Fire retardant to all standard fire codes - NFPA 701, CA Fire Marshal and UL 300
- Available in 15 colors and 5 weights
- Waterproof, rot and mildew resistant, anti fungal and anti-bacterial
- 10' wide sections - seams are strong and lay flat and smooth
- Custom-made to your gym floor dimensions
- Standard size available in 10' x 100' sections for quick shipment

Give us a call at: 800-877-1500
and ask us about custom scoreboards with advanced timing features that are ideal for gyms, arenas, and combination football, baseball, soccer, lacrosse, field hockey, and track facilities.



Weight Room Mats

- Made of 100% recycled rubber, available in 3/4" or 3/8" thickness and many colors
- Non-absorbent mats will not harbor or promote bacteria growth
- Quick installation, requires no cement or adhesives



mPerial® Detergent/Disinfectant

- EPA registered, FDA compliant
 - Highly dilutable
 - Proven effective against MRSA, Norovirus, HIV-1, VISA, and others
- 1 GAL. - MPERIAL1, 5 GAL. PAIL - MPERIAL5

Antimicrobial, Disinfectants & Cleaning



GamePlan-4-Sports PROFESSIONALLY APPLIED ANTIMICROBIAL PROGRAM



Antimicrobial program designed to protect the facilities and equipment your athletes, staff and trainers use each day.



Combat infection-causing microbial contamination and odor on all surfaces, equipment and fabrics within your sports facilities with **GamePlan-4-Sports**.



GamePlan-4-Sports is powered by ÆGIS Microbe Shield®, the most advanced, EPA registered antimicrobial available. The system is designed to provide a long-lasting layer of defense against a wide array of bacteria, mold and mildew.

The **GamePlan-4-Sports** treatment program is applied by mPact certified professionals. Its nanotechnology bonding chemistry will not rub off onto skin or leach into the air or ground - and it contains no heavy metals or harsh chemicals.

mPact-4-Sports DO-IT-YOURSELF PROTECTIVE TREATMENT



Do-it-yourself protective solutions specially formulated for sports facilities & equipment

mPact-4-Sports Multi-Purpose

Imparts a durable, invisible shield on sports gear and equipment which is protected from odors and stains caused by bacteria, mold and mildew.

Also Available: Antimicrobial Starter Kit for Locker Rooms



- 8 - mPact-4-Sports Multipurpose (1 qt.)
 - 1 - mPerial Detergent Disinfectant (1 gal.)
 - 1 - Pump-up Sprayer (2 gal.)
 - 2 - Trigger Sprayers (1 qt.)
 - 2 - Pro-Tex Hand Sanitizer (7.1 fl. oz.)
- LOCKERMP



Sweat X™ Laundry Detergent

- Sweat X Sport received the #1 overall ranking removing and eliminating 99% of all harmful bacteria that causes MRSA, STAPH and acne
- Sweat X Sport received the #1 overall ranking in stain removal for clay, blood, grass, mud in addition to successfully exfoliating paint particles from athletic wear
- Outperforms every leading laundry detergent per independent testing
- Nearly neutral pH level makes Sweat X safe to use on all athletic wear causing no wear and tear (decals) or discoloration
- The use of fabric softener is NOT needed due to a neutral pH level
- 100% biodegradable, 100% non-toxic with no impact on skin, inhalation or ingestion
- Sweat X's super concentrated formula requires less detergent per wash load than our competitors



Sweat X™ Stain Remover Spray

- Originally designed with and for the Cleveland Indians to remove the toughest stains around: mud, blood, grass, clay, dirt, pine tar and field paint
- Formulated with nano-technology to thoroughly lift and remove stains without damaging fabrics
- 100% biodegradable concentrate formula
- 100% nontoxic- ingestion, skin, inhalation toxicological studies; no fading or damaging of fabric or decals



Sweat X™ Odor Eliminator Spray

- Formulated to completely neutralize and lift odors from pads, shoes, helmets, gloves, gym bags, shin guards and more!
- Does not just mask the smell like other products; actually provides a long lasting odor elimination
- 100% biodegradable concentrate formula
- 100% nontoxic- no adverse impact on skin, inhalation, ingestion or the equipment itself. Safe to spray directly in gloves, helmets, skates, and cleats

PRODUCTS AVAILABLE IN COMMERCIAL SIZES: 55 gallon, 5 gallon, 1 gallon and 45 oz. bottles

Tennis Accessories

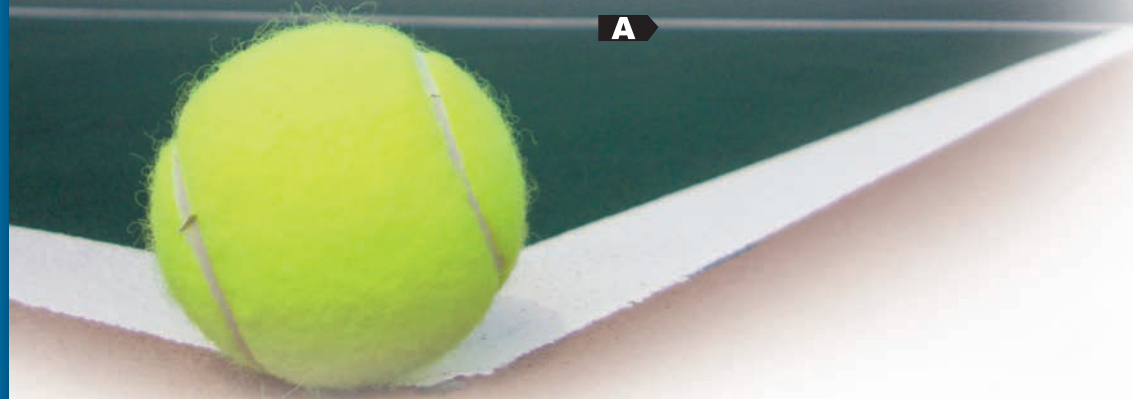

A

A Tournament™ Coating

- Gives your courts a professional appearance
- Color-in-depth hues remain rich and fresh after years of active play
- Creates an all-weather seal against sun, rain, snow and ice
- Provides excellent traction
- Fills and seals surface imperfections

RED - 20461, FOREST GREEN - 20460, LIGHT GREEN - 20464,
BLUE - 06159, GRAY - 06161, BEIGE - 20462

Tournament™ Colors:



B

B Court Patch™ Crack Filler

- Ready-to-use for quick and easy repairs of cracks, spalls and uneven areas
- Expands and contracts with weather cycles
- Court Patch Pourable is perfect for cracks up to 1/4" wide. Court Patch Trowelable is designed for deep repairs or wider cracks



Court Patch™ Colors:



D Edwards® 30LS

- Standard 42' long and 3.5mm braided polyethylene net body
- Heavy duty vinyl coated headband
- 5/8" fiberglass dowels included
- Edwards most popular net, and the one used at Wimbledon

E Edwards® Outback Double Center

- The same great features found in the 30LS except with an extra heavy spun polyester headband and five rows of double mesh at the top
- Wooden dowels included

TNODC42

F MacGregor® Super Pro 5000

- Standard 42' long and 3.6mm braided polyethylene net body
- Reinforced vinyl headband with extra coating to protect against abrasion
- Heavy-duty metal dowels included

TN42

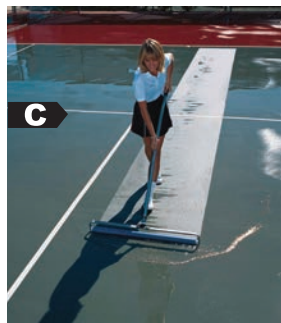

C

C Court Dry Roller

- Perfect for removing water from tennis courts
- Can be used on damp grass to improve field conditions
- Seamless 36" polyurethane foam roller COURT36; COURTRF (roller refill)



To see our full line of tennis accessories, visit us: pioneerathletics.com/tennis

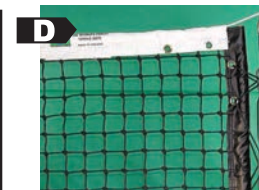

D



E



F

Parking Lot Maintenance and Weed Control

A Fastlane™

- Ready-to-use acrylic latex pavement paint creates bright and durable lines that dry in less than 10 minutes
- Easily applies with a roller or striper
- Polymer materials
- Ready-to-use and doesn't require any blending or mixing
- Great for high-traffic parking lots and streets that can't afford downtime
- Can be easily applied with a Brite Striper® 3000, Brite Striper® 3000SP or Graco Stripers
- Meets federal specification TT-P-1952E Type I

WHITE - FLW5
 BLACK - FLBK5
 HANDICAP BLUE - FLHBL5
 BLUE - FLB5
 RED - FLR5
 YELLOW - FLY5

B Fastlane™ Aerosol

- All of the same great features of bulk Fastlane in the convenience of an aerosol
- Can be easily applied using any of Pioneer's aerosol stripping machines designed for 18 oz. cans

WHITE - 73421
 BLACK - TSBK12
 HANDICAP BLUE - TSHBL12
 BLUE - TSB12
 RED - TSR12
 YELLOW - 73422

Fastlane™ Colors:

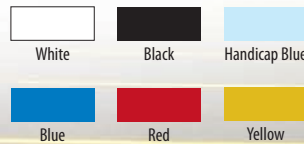

A



B



C Banish

1.2% Bromacil, water-based and non-selective Residual Concentrate.

- Use to control undesirable woody plants and brush
- Long-lasting residual action
- Highly dilutable formula
- Low odor formula
- Dilution: 1 gallon of Banish per 10 gallons of water
- Coverage: Annual weeds and grasses: 11 gallons covers up to 3,100 square feet; perennial weeds and grasses: 11 gallons covers up to 800 square feet

5 GALLON - KILL5B

D BareSpot®

Monobar-Chlorate non-selective, granular weed killer.

- Economical with quick knockdown
- Just one application provides a full season of control
- 98% Active ingredients
- Coverage: 1-2 lbs. per 100 square feet for general vegetation. 2-4 lbs. per 100 square feet for perennial weeds. 2-4 lbs. per 100 square feet under asphalt.

20 LB. BAG - 45902B

E Vacate

Non-selective, ready-to-use herbicide for year-long residual control.

- VOC Compliant
- Recommended for use only on non-cropland area
- Highly recommended for municipal weed control
- Long-lasting residual action
- Soil sterilant
- Coverage: 1,000 sq. ft. per gallon (43.5 gallons per acre) of undiluted weed killer.

5 GALLON - WEED5V

C



D

E



To view our full line of grounds and parking lot maintenance products visit us at: pioneerathletics.com/grounds

High School Football Field Layout Diagram

Hash Marks

Recommended 24" long and 4" wide

End Lines and Side Lines

Recommended 4" wide

Yard Markers

Recommended 24" long and 4" wide

Yard Line Numbers

Recommended 6' high x 4' wide. Placement should be 27" from sideline to top of yard line number.

*Note: Line width must be at least 4" and white in color.

*Note: The sidelines and endlines must be painted outside of the 160' x 360' box. The goal lines must be painted entirely within the end zone.

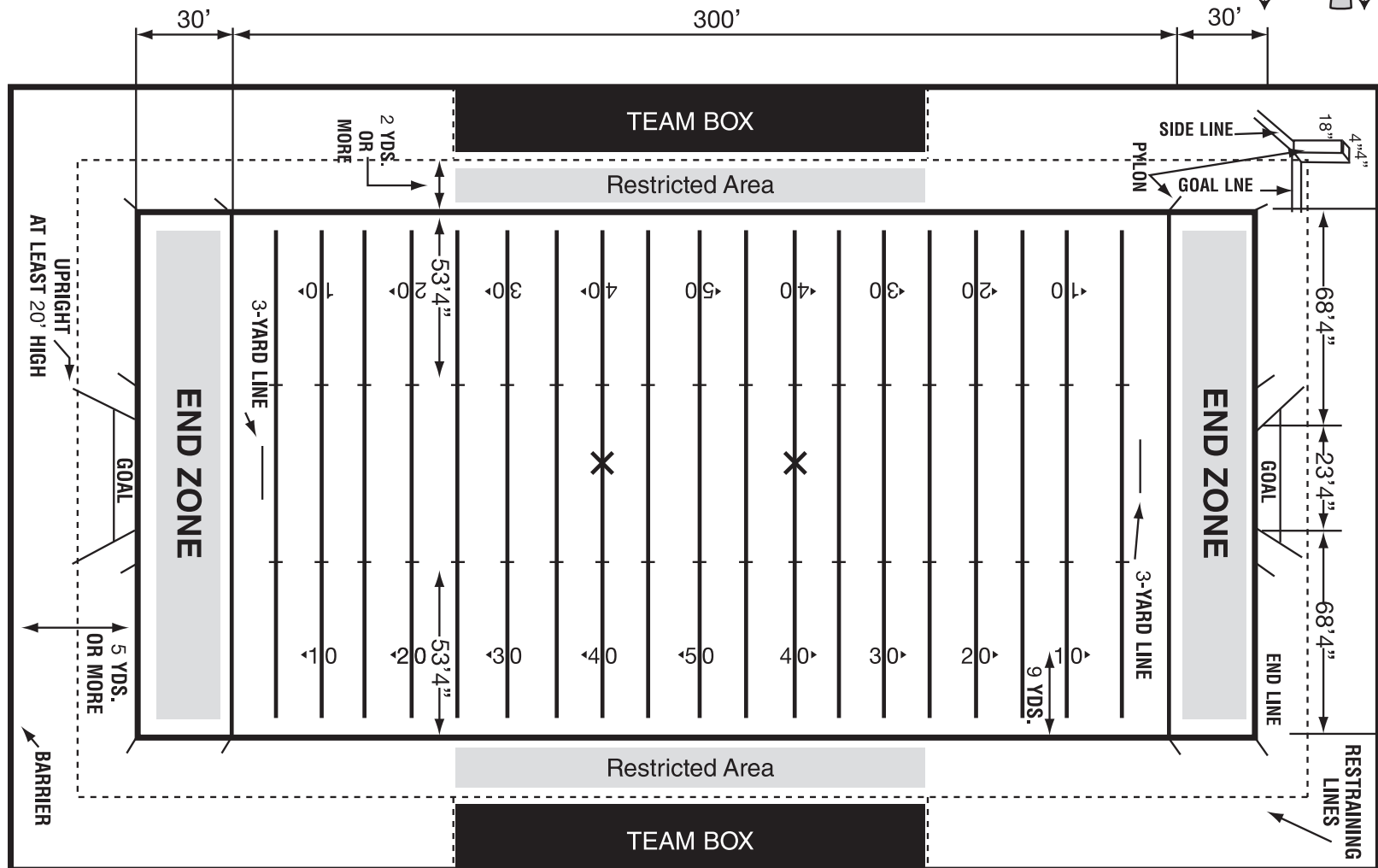
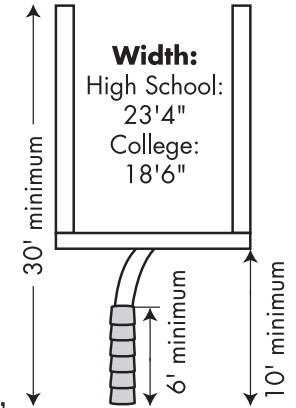

College Football Field Layout Diagram

Hash Marks

Recommended 24" long and 4" wide

End Lines and Side Lines

Recommended 4" wide

Yard Markers

Recommended 24" long and 4" wide

Yard Line Numbers

Recommended 6' high x 4' wide. Placement should be 27" from sideline to top of yard line number.

*Note: Line width must be at least 4" and white in color.

*Note: The sidelines and endlines must be painted outside of the 160' x 360' box. The goal lines must be painted entirely within the end zone.

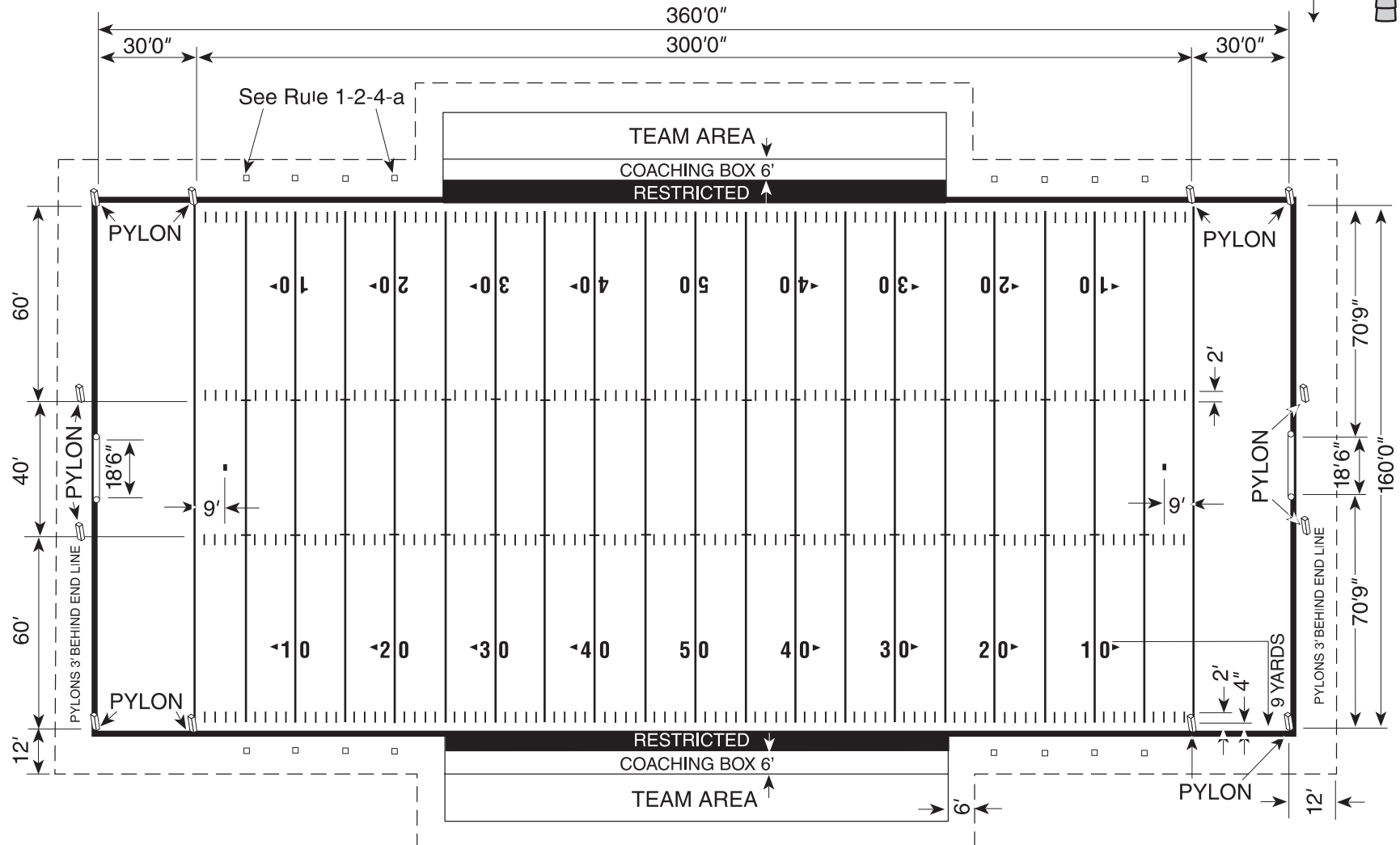
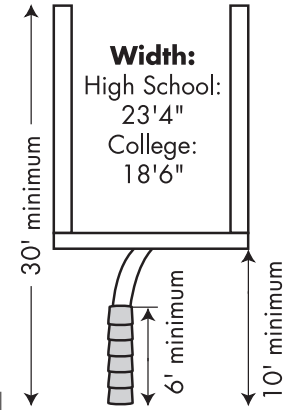

Soccer Field Layout Diagram

*Note: In soccer, the lines are painted inside the line of play.

*Note: Team area must be 10 ft. from the touchline.

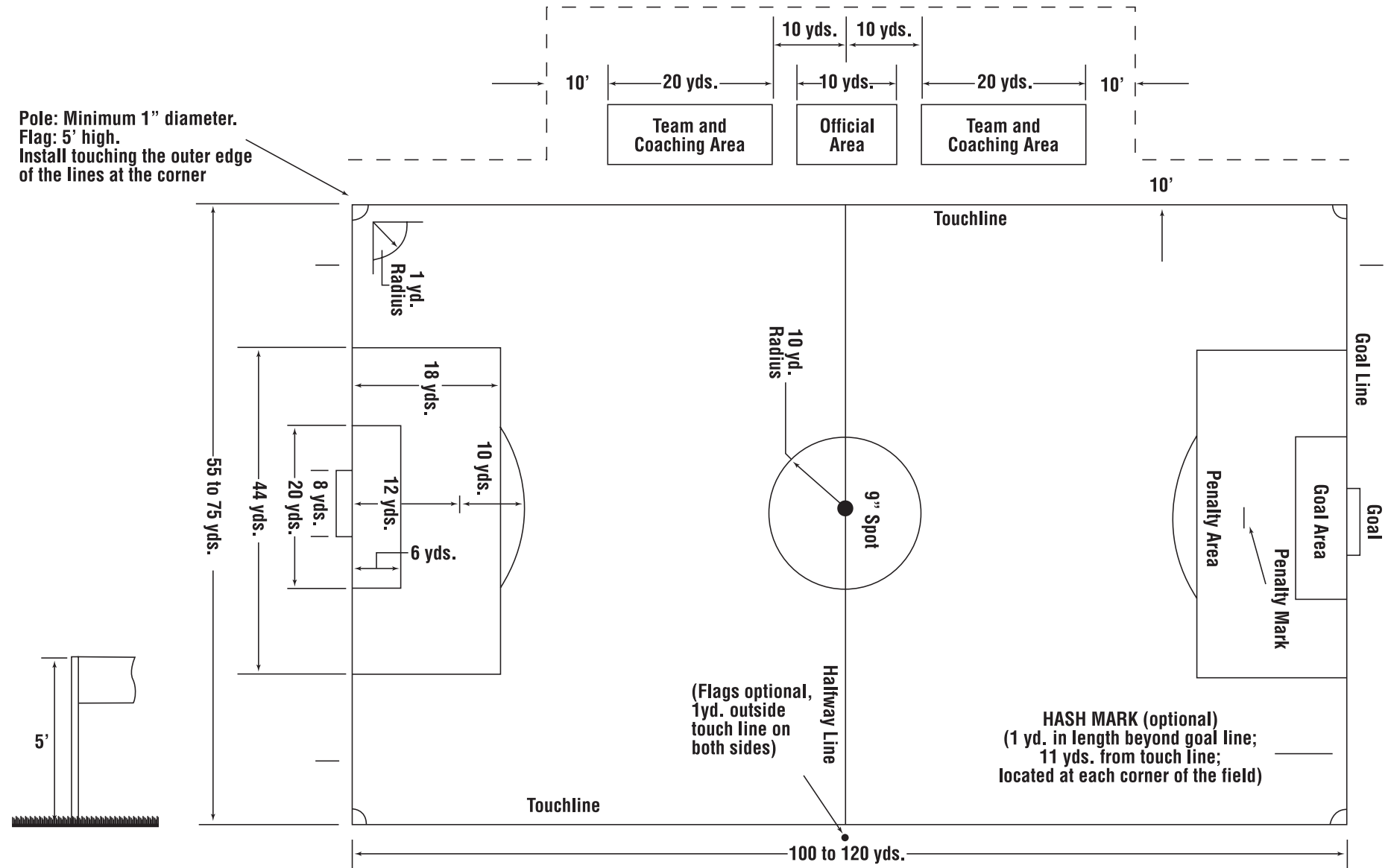

Baseball Field Layout Diagram

Distances for Other Leagues

Little League

- Base to Base: 60'
- Pitching Rubber to Home Plate: 46'
- Outfield Wall: 180' from Home Plate (optional 200' left to right)

Pony League

- Base to Base: 80'
- Pitching Rubber to Home Plate: 54'
- Outfield Wall: 250' from Home Plate (optional 300' left to right)

Babe Ruth League

- Cal Ripken (ages 5 - 12):
Bases: 60'
Pitching: 46'
- Baseball (ages 13-15):
Bases: 90'
Pitching: 60'6"
- Baseball (ages 16-18):
Bases: 90'
Pitching: 60'6"

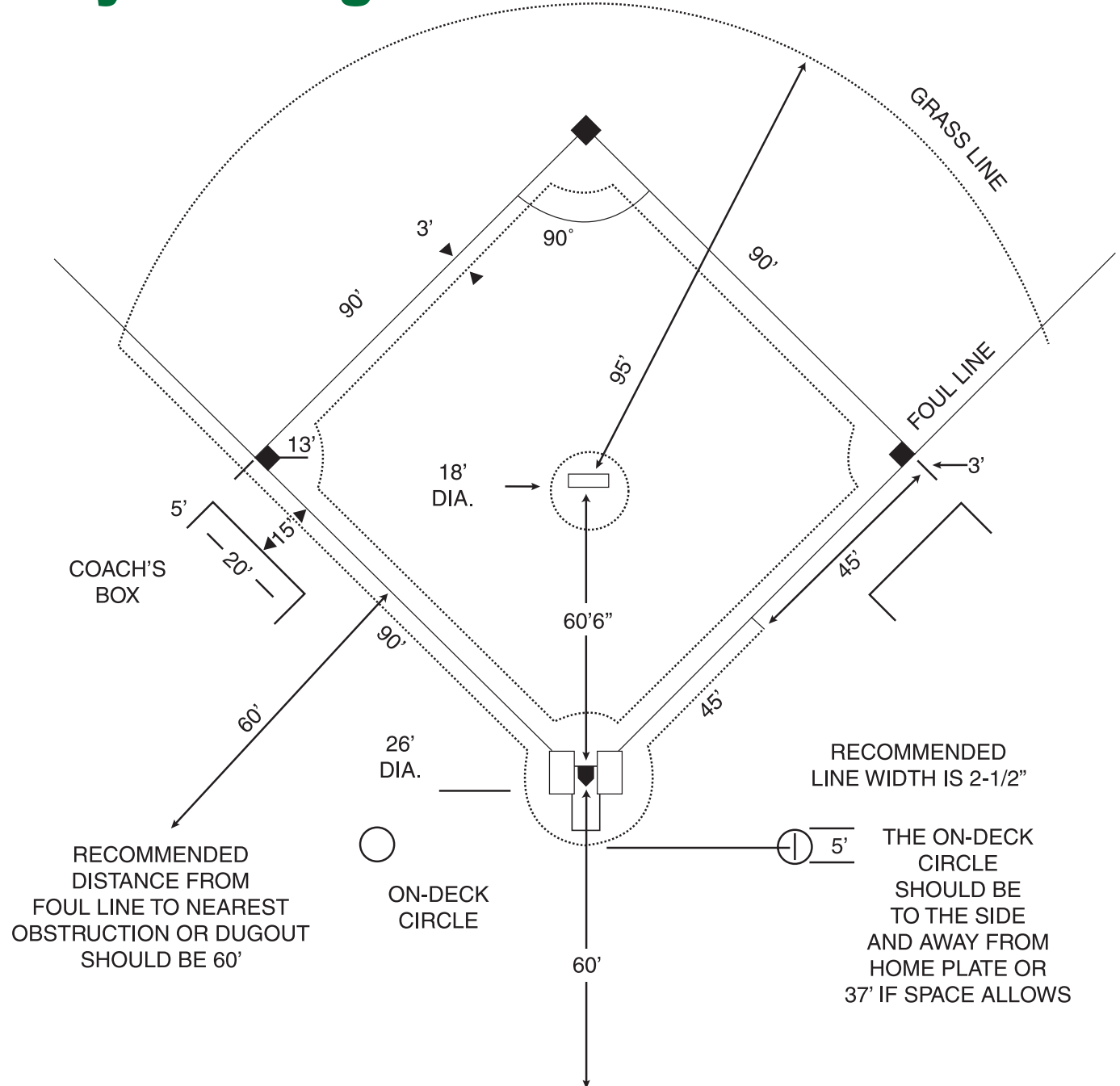
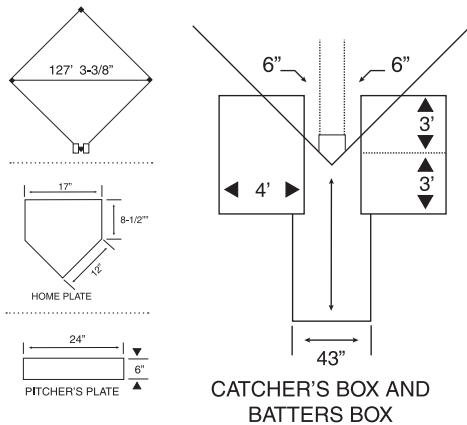

Softball Field Layout Diagram

OUTFIELD FENCE — ARC OF EQUAL DISTANCE — ALL FIELDS

RECOMMENDED OUTFIELD FENCE DISTANCES:

| | |
|---------------------------|-----------|
| Female or male fast pitch | 185'-235' |
| Female slow pitch | 250'-275' |
| Male slow pitch | 275'-300' |

RECOMMENDED
60-FOOT SKINNED INFIELD
(1-2-2)

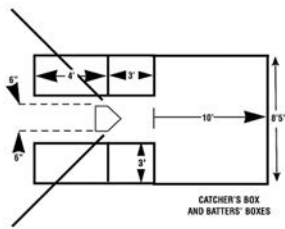
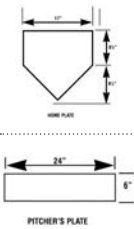
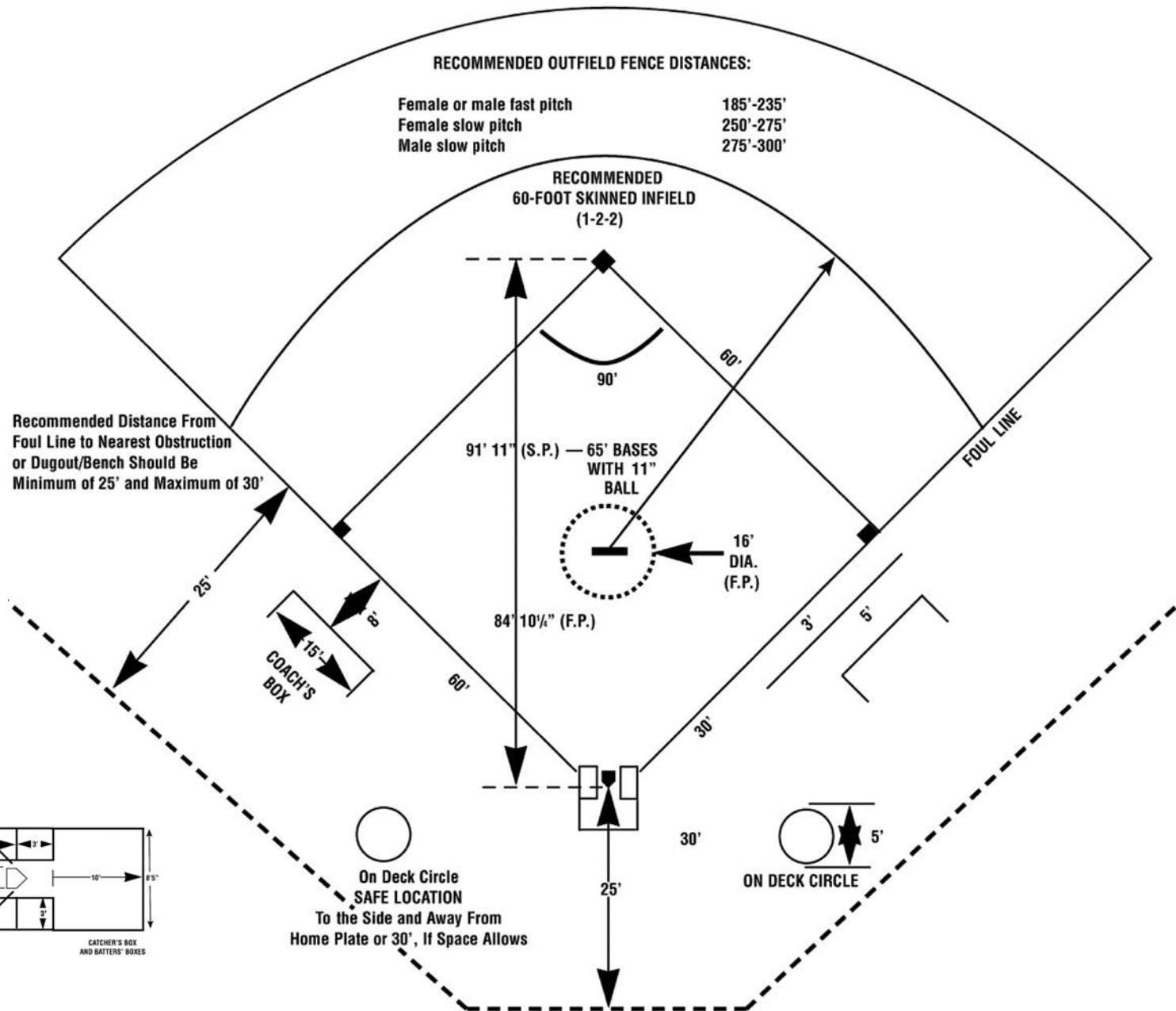

Men's Lacrosse Field Layout Diagram

*Note: If, because of a logo or any other reason, the home team's field is without a clearly marked center line, possession of the ball goes to the visiting team to begin the contest.

Men's Lacrosse: pictured to the right with the following change at center field:

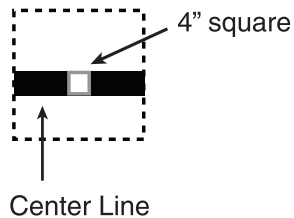

*Note: A 4" square line should be placed in the middle of the center line in a contrasting color.

Goal Circle

- 18' Diameter

Goal

- 6' Wide X 6' high X 7' deep

Goal Line

- 6' mark (center) of circle

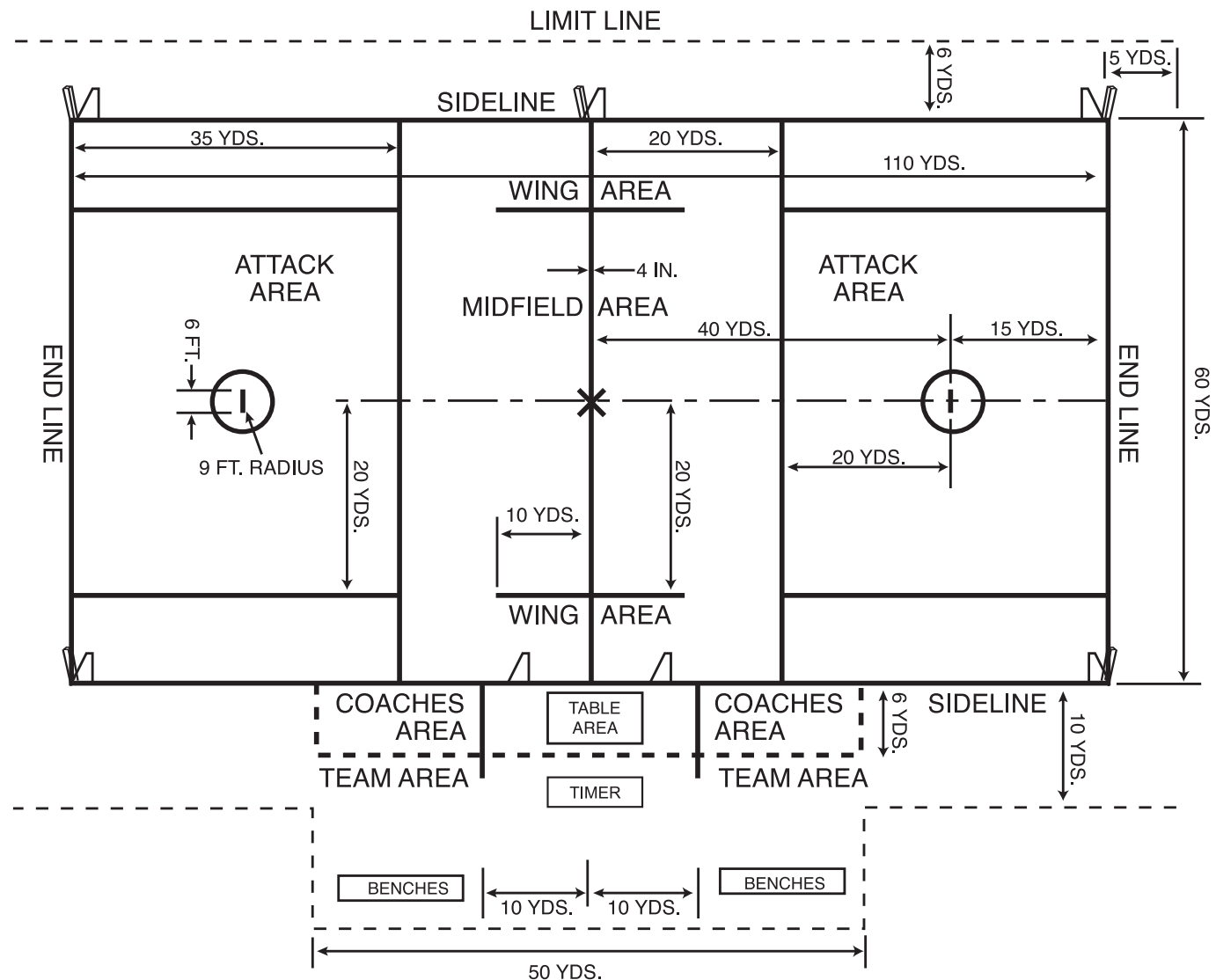
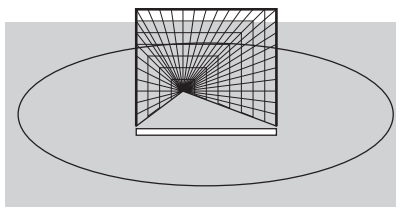

For other field dimension guides, visit: fieldlayouts.com

Women's Lacrosse Field Layout Diagram

Women's Arc Dimensions

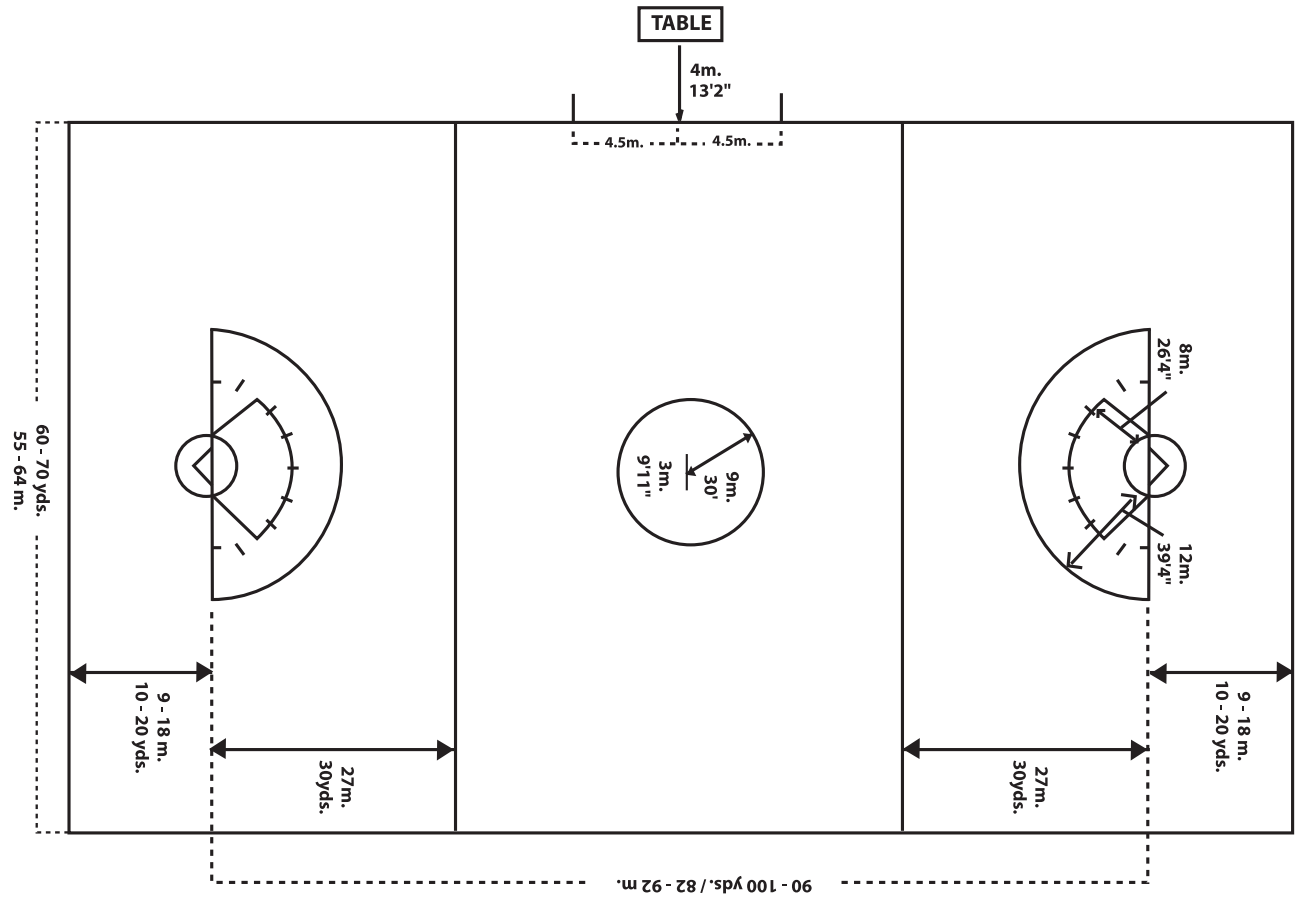
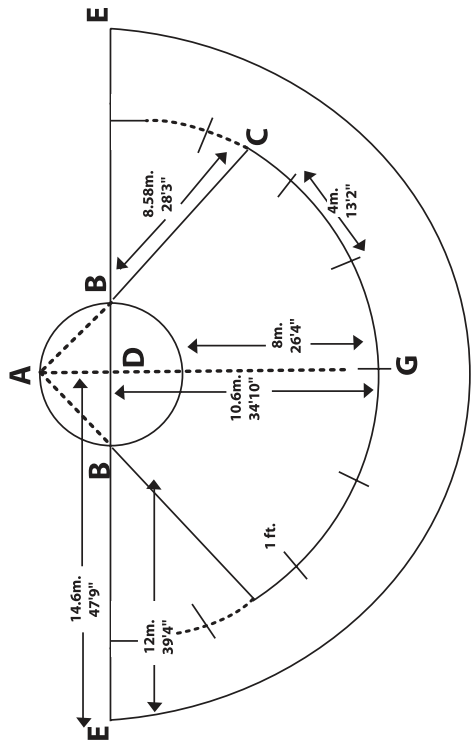

FIELDS OF EXCELLENCE[®]



Reach us by phone at 800-877-1500 or visit pioneerathletics.com/foe

A select number of outstanding fields will be recognized throughout each year and will be presented with:

- A vivid four-color banner carrying the "Pioneer Fields of Excellence" designation
- A framed certificate that can be proudly displayed
- Exclusive entry into a random drawing for Pioneer-sponsored scholarships for use by the school
- Press releases to national and local news outlets informing them of your accomplishment



Recognize the crew that makes your field a winner.

So much more goes into achieving excellence than just raw materials. A Fields of Excellence happens when the efforts of a talented crew, a well-maintained surface, and the best in paint, equipment and accessories all come together - just like a great masterpiece comes from partnership between artist, canvas and paint. Make sure your above-and-beyond-the-call-of-duty crew and your great fields get the recognition they deserve. Apply to the Pioneer Fields of Excellence Program.

What is the Pioneer Fields of Excellence Program?

This nationwide program recognizes hardworking individuals, schools and communities for their dedication and effort in keeping fields and sports facilities looking their best. It's no museum, but it is a lot like a hall of fame. It's the space we've created to honor great work and to foster school pride and community spirit in the process.

Who is eligible?

Any institution or organization that regularly maintains an outdoor athletic field can apply. Take a look at your field. Is there a maintenance crew that should be recognized for the care they give it? Do you know an unsung hero on the sidelines who keeps the field in excellent shape? Does it have a unique design or any special features? If you've answered "yes" to any of these questions, then apply today!

Apply for the Pioneer Fields of Excellence Award Today!

Call or click! Reach us by phone at 800-877-1500 or visit pioneerathletics.com/foe to download the application and upload your field photos.

On the application, describe in a short essay what makes your facility special. Print your completed application and have it signed by your facility manager. Include tips on keeping your facility in excellent shape. Send along digital photos of the field (all photos become the property of Pioneer). It's that simple.



Eliminate the need to remeasure your field

PLeeFiX™ Ground Markers

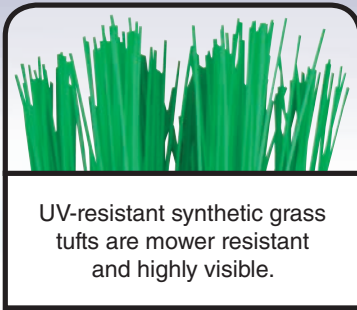

Watch the installation video at: pioneerathletics.com/pleefix



- UV-resistant synthetic turf tufts
- Fibers available in yellow, blue, red, orange, white, and green
- Recycled polypropylene spiral cone base
- Use to mark sprinkler heads and other potential field hazards
- Eliminates the need to re-measure natural grass fields prior to painting
- Can be used on sports fields for football, soccer, lacrosse, field hockey, rugby, baseball/softball, track and field, and golf
- Highly visible and mower resistant

Installs in just 3 easy steps:

