

Brite Striper 7000

Airless Riding

Field Line Striper



4529 Industrial Park Way, Cleveland, OH 44135 T 800.877-1500 • Pioneerathletics.com

Brite Striper 7000 Manual / 3033P.0125

Brite Striper 7000 Airless Riding Field Line Striper

Table of Contents

Precautionary Warning.....	Page 1
Assembly	Page 2-3
Operation	Page 3-7
Spray Tip Cleaning.....	Page 8
Cleaning Procedure.....	Page 8
Cleaning Procedure.....	Page 9 (Extended Periods or Winter Storage)
Maintenance	Page 10
Parts List.....	Page 11-12
Detailed Parts Pictures.....	Page 13-15
Airless Pump Detail	Page 16
Airless Spray Gun Detail.....	Page 17
Transaxle Service & Maintenance..	Page 18-19
Troubleshooting Guide	Page 20-21
Warranty.....	Page 22

Thank you for purchasing the Pioneer Brite Striper 7000 Airless Riding Field Line Striper.

Please read over the instructions and make sure you understand operating procedures before using the unit.

Please check the serial number on your unit. This Manual is for units with serial number 1036736 and above only. For units with serial numbers below 1036736, please contact Pioneer Athletics for the correct manual.



Brite Striper 7000 Airless Riding Field Line Striper



PRECAUTIONARY WARNINGS

- Please read and understand all operation instructions as detailed in this manual. Failure to follow specified instructions may result in equipment damage or serious injury to personnel up to and including death!
- **Moving equipment can cause severe injury.** Make sure area is clear of all personnel or obstacles before operation.
- **ALWAYS** stay seated while vehicle is in motion.
- **ALWAYS** keep hands and feet inside the perimeter of the vehicle.
- **NEVER** operate any moving vehicle under the influence of drugs or alcohol.
- **Skin Injection Hazard:** High Pressure spray can inject toxins into blood stream. If injection occurs, seek emergency medical treatment.
- **ALWAYS** release pressure in the system before changing or cleaning the spray tip.
- **ALWAYS** use the nozzle tip guard.
- **ALWAYS** engage the **Trigger Lock on the spray gun** before removing the spray gun for hand operation.
- **NEVER** place your hands or any body parts in front of the spray gun.
- **NEVER** point the spray gun at or spray other persons or animals.
- **NEVER** clean the spray tip while it is attached to the spray gun. Remove the spray tip from the gun to clean the tip guard.
- **NEVER** remove spray tip while cleaning the pump.
- **NEVER** use pliers to tighten or loosen high pressure fittings on pump, spray gun (paint) hose, or spray gun.
- Use only in well-ventilated area.
- Always consult your Facility Safety and/or Personnel Department for specified safety protocols prior to operating this equipment.



Brite Striper 7000 Airless Riding Field Line Striper

ASSEMBLY

1. Check for any damage that may have occurred during shipment. Advise the factory immediately if you see any damage. Remove the unit from the crate by removing the top boards, then the boards at the ends of the crate. Remove the tie down straps and then remove any shipping cartons.
2. Tilt the seat forward to access the transaxle release lever. (You may have to move the steering column forward to tilt the seat forward). Pull the lever towards the rear of the machine and over in the slot (Picture 1).

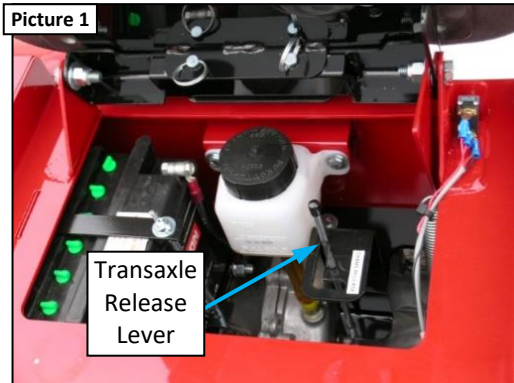

3. Release the parking brake if it is applied. You should be able to roll the machine out of the crate by pushing on the rear bumper. **DO NOT STAND IN FRONT OF THE MACHINE WHILE ROLLING IT OUT OF CRATE.**
4. The Brite Striper 7000 is shipped without the front bumper/spray head support attached. Align the two holes in the bumper bracket with the two holes in the frame. (The lifting lever/pedal should be on the top side of the bumper and on the right hand side as you face the machine).

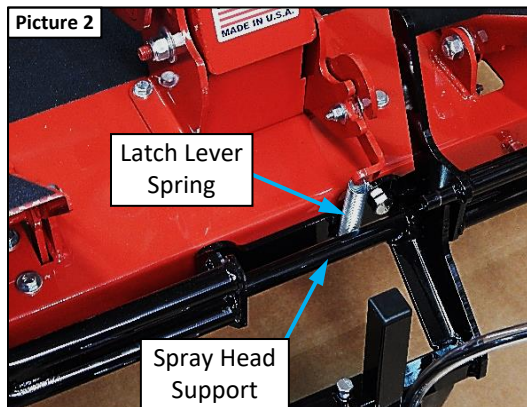

5. Insert the two 1/2" x 3-1/3" long bolts in the holes from the front. Place one flat washer, one lock washer and one hex nut on each bolt and then tighten the nuts.
6. Cut the tie that secures the lift lever lock spring to the machine. Hook the bottom of the spring in the loop on bottom of the bumper bracket.
7. Connect the battery. Tilt seat forward and connect the ground cable to the negative side of the battery.
8. Unpack the spray head with caster, spray gun mounting bracket, spray gun, and paint hose.
9. Press the foot release (lever on the left side of the steering column) to lower the spray head support tube. Mount the spray head assembly by sliding the spray head into the spray head support tube and then tightening the two pinch bolts.
10. The spray head may be adjusted to the left or right in the support tube so that the rear wheels will clear the striped line when turning.

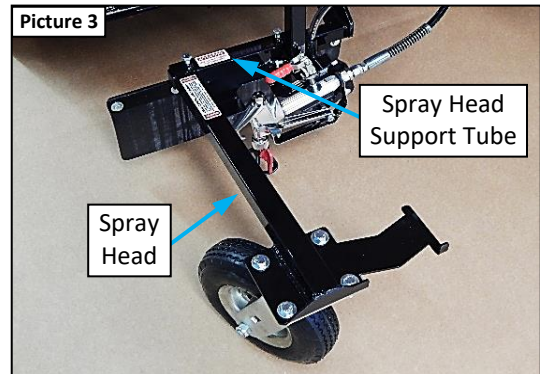

11. Slide the spray gun mount over the upright on the spray head and tighten the pinch bolt. Adjusting the spray gun mount up or down will adjust the spray width (Picture 3).
12. Place the spray gun in the gun mount without the hose attached and secure it with the clamp. (Picture 3)
13. The spray gun may have to be moved forward or backward in the gun mount so that there is approximately 1/8" of space between the trigger and the lifting bar. This should also leave enough room to push the trigger lock sideways.



4529 Industrial Park Way, Cleveland, OH 44135 T 800.877-1500 • Pioneerathletics.com

Brite Striper 7000 Manual / 3033P.0524

Brite Striper 7000 Airless Riding Field Line Striper

ASSEMBLY (CONTINUED)

14. If the trigger lock will not move, release the gun clamp, and slide gun forward or backward until you can push the trigger lock. **NOTE:** *To release the trigger lock, push the lock in from the right side (inside) of the gun.*
15. Attach one end of the spray hose to the pump outlet with a 3/4" wrench and the other end to the spray gun. To secure the hose on the spray gun you will need a 3/4" and a 9/16" wrench as it has a swivel fitting.
16. Loop the additional hose over the hanger on the left side of the spray tank. Make sure hose does not contact the tire. Route the hose through the snap link on the left fender, and around the post at the left front corner of the deck.
17. Always check the oil level in the engine before starting (SAE 5W-30 Full Synthetic).
18. Make sure the static chain hanging from the bottom side of the transaxle is contacting the ground.

DRIVING OPERATIONS

1. Before starting, set the brake with the hand lever to the left of the seat.
2. Go to the rear of the machine and push the (#7) fuel lever on the engine to the OPEN position (move towards the paint tank).
WARNING: Any time engine is off for extended periods, shut off the fuel lever on the engine. If the fuel lever is left on, gas can drain into engine oil sump. If you check the oil and oil pours out of the sump, **STOP** and call the factory. There are several steps to take before you can start the engine without damage.
3. Pull up on choke knob.
4. Place throttle lever in the FAST position.
5. Start the engine. When the engine begins to stumble, push the choke knob down to the OFF position.
6. Set the throttle at to approximately ¾ open (where engine runs smoothest). The engine does not need to run at full speed to operate the spray pump.
7. Release the parking brake and press on the top of the right foot pedal to move forward.
8. Pushing on the bottom of the right pedal will move the machine in reverse.
9. To stop, release the foot pedal.
NOTE: If machine will not move, set the parking brake, exit the machine, and lift the seat. Make sure that the transaxle release lever is in the forward position. Enter the machine and release the parking brake. It should now move when you press on the right pedal.
10. To travel long distances when not spraying, or to load the machine onto a trailer, lift the spray head using the foot lever on the left side of the steering column. The spray head will lock in position when fully lifted. This also locks the spray gun so that it may not be activated when the spray head is lifted.
11. When loading the machine on a trailer, approach the ramp slowly to assure the gun will clear the ramp and trailer. You may have to raise the gun or possibly remove it if the ramp is too steep.
NOTE: **TOWING if unit becomes disabled:** The Parking Brake must be released, and the Transaxle Release Lever must be moved to the Disengaged Position. **Do Not Exceed 2 mph.** Towing distance should not exceed 500 feet. The machine should be trailered if a greater distance is required.



4529 Industrial Park Way, Cleveland, OH 44135 T 800.877-1500 • Pioneerathletics.com

Brite Striper 7000 Manual / 3033P.0524

Brite Striper 7000 Airless Riding Field Line Striper

HOUR METER AND TACHOMETER OPERATION

TO SET THE TACHOMETER (SPARK PLUG FIRING REVOLUTION)

Press and hold the **S1** button for 4 seconds. The LCD will display **01** (spark plug fires twice per revolution), **02** (once per revolution), **03** (every other revolution), **04** (hours only, will not display RPM). Once you find your desired spark plug firing pattern, release the **S1** button. The LCD will blink for 8 to 10 seconds and return to total hour meter mode. The default for the standard model is **02** (once per revolution). This default can be changed during manufacturing.

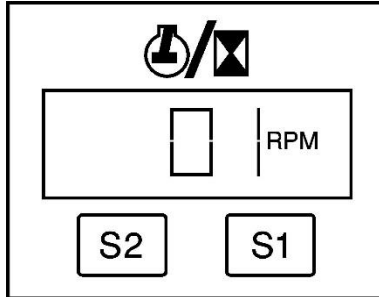

TO SET THE MAINTENANCE INTERVAL TIMER

Press and hold down the **S2** button for 4 seconds. The right most digit on the LCD will flash and the **SERVICE** icon will be displayed. Pressing and holding the **S1** button will cause the flashing digit to automatically increment. When the desired number has been reached release the **S1** button and press the **S2** button for 1 second to increment to the next digit. Repeat above steps until the service time interval has been entered. After 14 to 16 seconds with no buttons pressed, the LCD display will return to total hours mode.

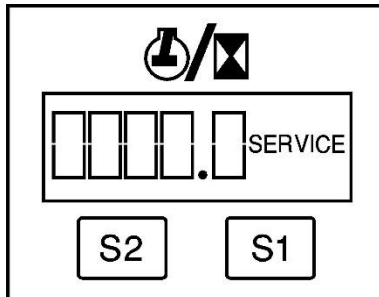

ACTIVATING THE MAINTENANCE INTERVAL TIMER

Press and hold the **S1** and **S2** button simultaneously for 4 seconds. The two digits will increment to 20 seconds and then return to total hours mode. When the engine is running and the maintenance time has reached zero, the service icon will come on.

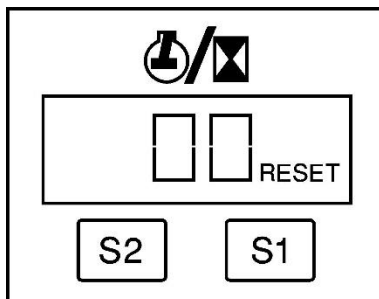

4529 Industrial Park Way, Cleveland, OH 44135 T 800.877-1500 • Pioneerathletics.com

Brite Striper 7000 Manual / 3033P.0524

Brite Striper 7000 Airless Riding Field Line Striper

VIEWING MAINTENANCE INTERVAL

Press and hold the **S2** button for 4 seconds to view remaining time of your maintenance interval. To continue current maintenance, do nothing. If you would like to start a new maintenance interval, repeat steps 4 & 5 again. Each time you want to view the remaining time of your maintenance, press, and hold **S2**.

RESETTING THE SERVICE ICON

Press and hold the **S1** and **S2** buttons for 20 seconds. The service icon will shut off. The maintenance time will automatically default to the number previously programmed.

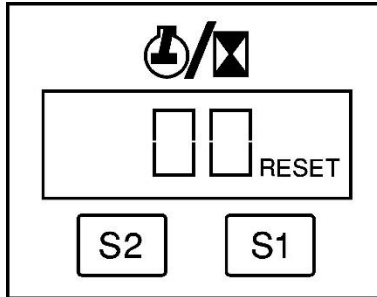

TO DISPLAY HOURS ONLY

Press and hold the **S1** button until **04** is displayed. Release the **S1** button and the display returns to total hours after 8 to 10 seconds. When the engine is running the display will show hours only, no RPM and the Hour Icon will blink.

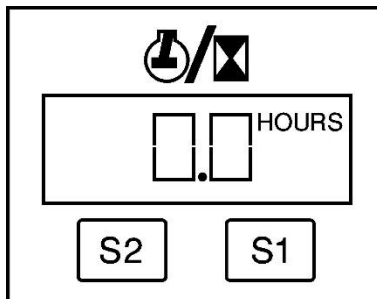

TO RESET TOTAL HOURS AND MAINTENANCE TIME

Press and hold the **S1** button until **05** is displayed. Release the **S1** button and after 8 seconds the display will return to total hours. Press and hold **S1** and **S2** simultaneously for 20 seconds and the meter will perform a total reset. The total reset option can be removed during manufacture.

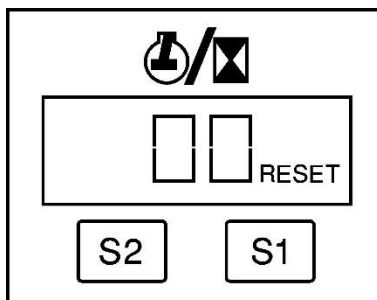

4529 Industrial Park Way, Cleveland, OH 44135 T 800.877-1500 • Pioneerathletics.com

Brite Striper 7000 Manual / 3033P.0524

Brite Striper 7000 Airless Riding Field Line Striper

SPRAY OPERATIONS

First time use or after extended periods of not using the machine use water to test operations and settings. The Brite Striper 7000 is designed to be used with water based athletic field marking paints.

1. Add 10-50 gallons of water or paint to the spray tank and 1-2 gallons of water to the purge tank.

ALWAYS STRAIN THE PAINT BEFORE USE!

2. Push the outlet push button 3 times to ensure the outlet valve is moving. The push button is located on the bottom left corner of the pump opposite the spray hose.
3. Turn the pressure control valve fully clockwise to the high pressure setting. **DO NOT OVER TIGHTEN!**
4. Turn the prime/spray valve to the prime position. (Circular arrow symbol in-line with the arrow on the side of the pump block.)
5. Ensure the spray gun trigger lock is disengaged.
6. Ensure the spray gun tip is in the spray position. (The arrow on the spray tip points toward the ground.)
7. Check that the tank feed valve (located under the left side of the tank by the white filter housing) is in the open position (handle in-line with hose) and the purge feed valve is in the closed position (handle crosswise to hose).
8. Start engine as instructed in steps 1-6 in the Driving Operations.
9. Engage the pump by moving the engaging lever on top of the belt guard to the "On" position.

10. With the prime/spray valve in the prime position, fluid should flow through the bypass hose back into the paint tank.
11. Let the pump run in the prime position for one minute or until air bubbles are not seen from the bypass hose.
12. Turn the prime/spray valve to the spray position. (Spray gun symbol in line with the arrow on the side of the pump block.) **NOTE:** A knocking sound should be present at the pump, indicating the pump is reaching full relief pressure.
13. With the spray head in the down position, activate the foot pedal trigger and paint (or water) will spray from the gun. Releasing the pedal will stop the spray. Note: When the spray head is in the up position, the spray pedal will be locked, preventing accidental discharge.
14. Adjust the pressure by turning the pressure valve counter clockwise until spray pattern decreases, then increase pressure by turning clockwise just to where you get a good even spray pattern. **Operating the pump at the lowest pressure while still producing a quality line can increase the life of the pump.**
15. Adjust the spray gun height for the proper line width.
16. **When finished spraying or if machine will be left unattended for any amount of time, turn the prime/spray valve to the prime position, and pull spray trigger to release pressure from the system.**



4529 Industrial Park Way, Cleveland, OH 44135 T 800.877-1500 • Pioneerathletics.com

Brite Striper 7000 Manual / 3033P.0524

Brite Striper 7000 Airless Riding Field Line Striper

QR code link for
bleed procedure video



OPERATIONAL NOTES

- NOTE: If the pump primes and air bubbles continue to appear in the hose after one minute, the suction hose fitting may not be tight enough or the rubber washer may be worn. Turn off the machine, turn the spray valve to prime position, and then pull the spray gun trigger to open the gun and release the system pressure.
- Remove the garden hose fitting at the inlet side of the pump, depress the inlet valve stem to make sure it is free, inspect the washer to make sure it is seated and in good condition. Re-attach the garden hose fitting making sure that it is tight. You may have to **lightly** snug it with pliers if you continue to get air bubbles. Start the engine and repeat the first steps for operation.
- If the pump will still not prime, back out the pressure control valve knob until it feels loose (several turns), and then turn the Prime/Spray Valve to the prime/re-circulate position. Push the Outlet Prime Button, located at the bottom left corner of the pump, three times. Let the pump run for up to 10 minutes, and then turn the pressure control valve knob in clockwise, just until it stops. The pump should now prime. If the pump will still not prime, PLEASE CALL THE FACTORY.



Brite Striper 7000 Airless Riding Field Line Striper

SPRAY TIP CLEANING DURING USE

1. With the spray head down, place the Prime/Spray Valve in the prime position, and then press the spray trigger pedal to release the system pressure.
2. Turn the spray gun tip to the clean position. (The spray tip arrow pointed toward the gun.)
3. Turn the Prime/Spray Valve to the spray position and trigger the gun. This should clear the spray gun of blockages. Turn the prime/spray valve to the prime position, and then trigger the gun to release the system pressure.
4. Reverse the spray gun tip so that the spray tip is in spray mode (spray tip arrow pointed at the ground).
5. Turn the Prime/Spray Valve to the spray and then resume spraying.
6. If the spray tip appears to be clean and gun will not spray properly, check the spray gun filter located in the spray gun handle. The filter can be cleaned with soap and water. However, if the filter is too clogged or dirty to clean it must be replaced.
7. If the spray gun is still clogged, proceed to the cleaning procedure below.

CLEANING PROCEDURE

1. The NewRider™ 5000 is equipped with an on-board purge tank that holds up to 2.5 gallons of water. Make sure this has 1-2 gallons of water.
2. Check that the ball valve on the bottom of the purge tank is in the open position (valve handle in line with hose).
3. Turn the paint tank feed selector valve (located below the tank on the left side) to the closed position (handle crosswise to hose).
4. Turn the purge feed valve to the open position (handle in line with the fittings).
5. Turn the Prime/Spray Valve to the prime position.
6. Start the engine and move the pump engaging lever to the "On" position. Watch until the fluid returning to the tank runs clear.
7. Turn the Prime/Spray Valve to the spray position and trigger the gun until the spray runs clear.
8. Clean the spray tip if needed with a nylon bristle brush. **DO NOT** use brushes with metal bristles or any metal object to clean the spray tip of dried paint. Replace the tip if it cannot be cleaned.
9. If the spray tip appears to be clean and the gun will still not spray, check the spray gun filter located in the handle of the spray gun. If the filter cannot be cleaned it must be replaced.
10. Drain the paint tank of any unused paint. You may now rinse the inside of the paint tank.
NOTE: You may want to place the machine on a slight incline, so the drain outlet of the tank is at the lowest point for better draining.
11. With most of the water drained from the purge tank, (leave about 1" depth) and add approximately 4 ounces (1/2 cup) of *Pump Defender* into the purge tank.
12. Start the engine and leave the Prime/Spray Valve in the prime position, and the pump engaging lever in the "On" position. Watch the returning fluid until you see *Pump Defender* appear from the return hose.
13. Move the pump engaging lever to "Off" and turn off machine. Press spray gun trigger to relieve any pressure.
14. Check the in-line pump filter once each week. (White plastic filter at bottom of tank near tank selector valve). Turn the purge tank feed selector valve to the "Off" position.
15. Unscrew the bottom half of the filter. Clean the filter bowl and screen, and then re-install them.
NOTE: There is a gasket between the lower half of the filter housing and the upper half. Check that this is in place when installing the bottom half of the filter. **Hand Tighten Only.**





4529 Industrial Park Way, Cleveland, OH 44135 T 800.877-1500 • Pioneerathletics.com

Brite Striper 7000 Manual / 3033P.0524

Brite Striper 7000 Airless Riding Field Line Striper

CLEANING FOR EXTENDED PERIODS OF NON-USE OR IN FREEZING CONDITIONS

1. Clean as instructed in the Cleaning Procedures and drain the purge tank completely of water.
2. Add 16 ounces (1/2 bottle) of *Pump Defender* to the purge tank.
3. Start the engine and place the pump engagement lever in the "On" position. Place the Prime/Spray Valve in the prime position and then operate pump until you see *Pump Defender* in the bypass hose.
4. Place the Prime/Spray valve in the spray position and trigger the spray gun until you see *Pump Defender* liquid spray from the gun. Once liquid starts spraying from the gun quickly release the trigger.
5. Return the Prime/Spray Valve to the prime position and then place the pump engagement lever in the "Off" position.
6. Trigger the spray gun to release any pressure from the system.
7. Remove as much fuel from the engine gas tank as possible or add fuel stabilizer to fuel.
8. Close the fuel shut off valve on the engine, and then run the engine until it runs out of gas.
9. The machine may now be stored in freezing temperatures.
10. Drain and change the engine oil in the spring.

	
	<p>PRECAUTIONARY WARNINGS</p> <ul style="list-style-type: none">• ALWAYS release the pressure in the system before changing or cleaning the spray tip. (Place the Prime/Spray Valve in the prime position, turn off the machine, and trigger the spray gun to release the system pressure).• NEVER use fuels to clean the equipment.• DO NOT use solvents containing halogenated hydrocarbons such as methyl bromine, carbon tetrachloride and ethyl iodine.• DO NOT attempt to clean a clogged gun filter. You must replace it.• DO NOT use brushes with metal bristles or any metal object to clean the spray tip of dried paint. Replace the tip if it cannot be cleaned.
	



Brite Striper 7000 Airless Riding Field Line Striper

MAINTENANCE

ITEM	CHECK	MAINTENANCE ACTION
Engine Oil 5W-30 Full Synthetic	Before each use	Change the oil after the first 20 hours of operation, and then every 100 hours.
Spray Pump	Before and after each use	Use pump protector every time you store the machine.
Pump Inlet Hose	Before each use	Replace it if it is nicked or has cuts.
Spray Hose	Before each use	Replace it if it is nicked or has cuts.
Bypass (Recirculation) Hose	Before each use	Replace it if it is nicked or has cuts.
Spark Plug & Air Filter	Every 4 Months	Clean or change as needed.
Spray Head, Transaxle Linkage, and Steering Linkage Pivot Points	Before each use	Lubricate with light machine oil, such as 3-in-1 or spray oil such as Slick-50 One Lube.
Spray Tip	Before each use	Replace it if the spray pattern becomes uneven or if the tip becomes worn.
Inline Filter	Clean weekly	Replace every 400 gallons or if clogged.
Rear Axle Steering Knuckles	Lubricate weekly	Use a high quality bearing grease.
Spray Gun Clamp and Cable	Check weekly	Lubricate with spray oil, such as Slick 50 One Lube.
Tires	Check weekly	Check air pressure. Axle bearings are sealed and do not require service.
Pump Engaging Lever	Lubricate weekly	Lubricate with spray oil, such as Slick 50 One Lube.
Spray Gun Filter	Check monthly	Replace it if the filter becomes clogged. Every 50-250 gallons.
Battery	Check monthly	The AGM Sealed battery is maintenance free and only needs replaced when bad. Charge it if needed.
Air Filter	Check monthly	Change when dirty.
Transaxle Filter	Every 12 months	Change the transaxle oil and filter after the first 75-100 hours, and then every 400 hours after that.
Transaxle Oil Warning: Use ONLY Pioneer Filter 10003778. Failure to use this filter will void the warranty.	Check if performance is off or transaxle is noisy	Top off to the cold fill line on the reservoir under the seat. Warning: Use ONLY Mobil 1 Full Synthetic 15W50 Motor Oil. Failure to use the correct oil type and viscosity will cause damage to the transaxle and void the warranty.
Outlet Push Button	Before each use	Replace every 1000-1500 gallons or if it is leaking. (Replace with the Outlet Valve)
Inlet Valve	If pump does not prime	Replace every 1000-1500 gallons or if bad.
Washer, Pump Inlet Hose	Pump losing pressure	Washer- every 100-250 gallons.
Outlet Valve	If pump does not prime	Replace every 1000-1500 gallons or if bad.
Prime/Spray Valve	Before each use	Replace every 1000-1500 gallons. Replace if it stops working or if it is leaking.
Pump Inlet Hose	Before each use	Replace it if it is nicked or has cuts.
General Cleaning	As needed	DO NOT use high pressure power washers. DO NOT use solvents. Soap and water only.



4529 Industrial Park Way, Cleveland, OH 44135 T 800.877-1500 • Pioneerathletics.com

Brite Striper 7000 Manual / 3033P.0524

Brite Striper 7000 Airless Riding Field Line Striper

PARTS LIST

<u>Item#</u>	<u>Description</u>	<u>Part Number</u>
1	18ah SLA AGM Battery, 6-7/8" L X 3-7/16" W X 6-1/8" H	10003163
2	Transaxle Oil Reservoir	10003000
3	Transaxle Release/Engage Lever	10003727
4	Seat Bracket	10002956
5	Empty Seat Safety Switch	10004923
Not Shown	Neutral Switch (Under Deck on Shift Linkage)	10002913
Not Shown	Brake Safety Switch (Under Seat Console)	10004923
6	Seat Retention Pins (2 Required)	10003214
7	Fuel Shut-Off	N/A
8	Air Filter Housing	N/A
9	Air Filter	10001926
10	Purge Tank Shut-Off Valve	10002366
11	Purge Tank	10003198
12	Spray Head	10003746
13	Swivel Caster	10001434
14	Front Bumper	10003276
15	Gun Control Cable	10002521
16	25' Airless Paint Hose	10000458
17	Airless Spray Gun	10005115
17a	419 White Spray Tip, Up to 4" line width	10005230
17b	619 White Spray Tip, 4"-8" line width (standard)	10005151
18	Spray Gun Clamp	10005152
19	Gun Mount Assembly	10005137
20	Gun Trigger Lifting Bar	N/A
21	Spray Gun Filter	10000641
22	Spray Gun Trigger Lock	N/A
23	Spray Tip Guard (Part of Spray Gun)	10005116
24	Hand Brake	10004693
25	Choke Cable Assembly	10004748
26	Throttle Cable Assembly	10002486
27	Ignition Switch (Need Exact Engine Model and Serial Number for Special Order)	N/A
28	Hour Meter	10002241
29	Rear Bumper	10003277
30	50 Gallon Paint Tank	10003303
31	Fuel Tank Cap	N/A
32	Column Release/Lock Lever	10003729
33	Motion Pedal (Forward/Reverse)	10003730
34	Spray Pedal	10003731
Not Shown	Return Spring (Spray Pedal)	10000692
35	Spray Head Support with Lifting Lever	10003751
36	Spray Head Latch Lever	10003725
37	Front Wheels	10004033
38	4 Bolt Hub for Front Wheels	10004032



4529 Industrial Park Way, Cleveland, OH 44135 T 800.877-1500 • Pioneerathletics.com

Brite Striper 7000 Manual / 3033P.0524

Brite Striper 7000 Airless Riding Field Line Striper

PARTS LIST CONTINUED

<u>Item #</u>	<u>Description</u>	<u>Part Number</u>
39	Rear Wheels	10002991
40	Purge Tank Feed Selector Valve	10004110
41	Purge Hose	10004816
42	In-Line Filter	10000369
Not Shown	Filter Screen for In-Line Filter	10000100
Not Shown	O-ring Gasket for In-Line Filter	10001543
43	Bulkhead Fitting (Tank Outlet)	10004114
44	Paint Tank Feed Selector Valve	10004110
45	Paint Tank Outlet Hose	10004118
46	AX86 V-Belt (Final Drive)	10002743
47	Flat Idler Pulley (Final Drive)	10003197
48	Spring (Final Drive Belt Tensioner)	10002755
49	4" Composite V-Idler Pulley (Final Drive)	10002738
50	Drag Link	10003716
51	Pulley (Gearbox Final Drive)	10003053
52	Pillow Block (2 Required)	10002415
53	Tie Rod	10003756
54	Frame Rail Flat Idler Pulley (Final Drive Belt)	10003164
55	Pulley and Fan Assembly (Transaxle)	10002999
56	Oil Filter (Transaxle)	10003778
57	Spring (Parking Brake Return)	10003029
58	Transaxle Parking Brake Mechanism	N/A
59	V-Idler Pulley (Pump Drive Engage)	10003815
60	Spring (Primary Drive Belt Tensioner)	10003029
61	Spring (Pump Drive Idler)	10002897
62	V-Idler Pulley (Primary Drive Belt Tensioner)	10003815
63	Pulley (Engine) 2-Required	10003819
64	Gearbox	10002963
65	Pulley (Gearbox Drive)	10003052
66	Belt (Primary Drive) AX27	10003020
67	Pulley (Pump Drive)	10003048
68	Belt (Pump Drive) Kevlar 4L320	10003019
69	Ball Valve (Tank Drain)	10003362
70	Bulkhead Fitting (Tank Drain)	10003241
71	Steering Wheel	10003241
72	Seat	10003302

ENGINE LUBRICANT AND PARTS

<u>ITEM</u>	<u>SPECIFICATIONS</u>
Engine	Honda GX390UT2 QAE2
Oil Capacity	38oz SAE 5W-30 Full Synthetic
Spark Plug	NGK Part Number BP6ES
Air Filter	Part Number 10001926



4529 Industrial Park Way, Cleveland, OH 44135 T 800.877-1500 • Pioneerathletics.com

Brite Striper 7000 Manual / 3033P.0524

Brite Striper 7000 Airless Riding Field Line Striper

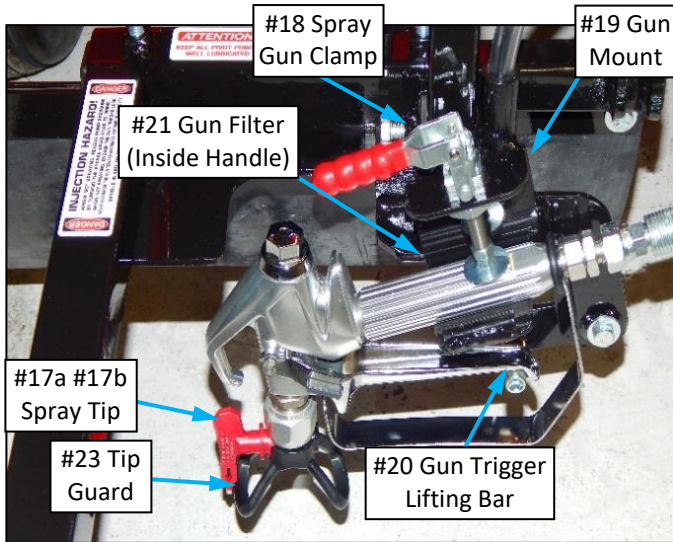
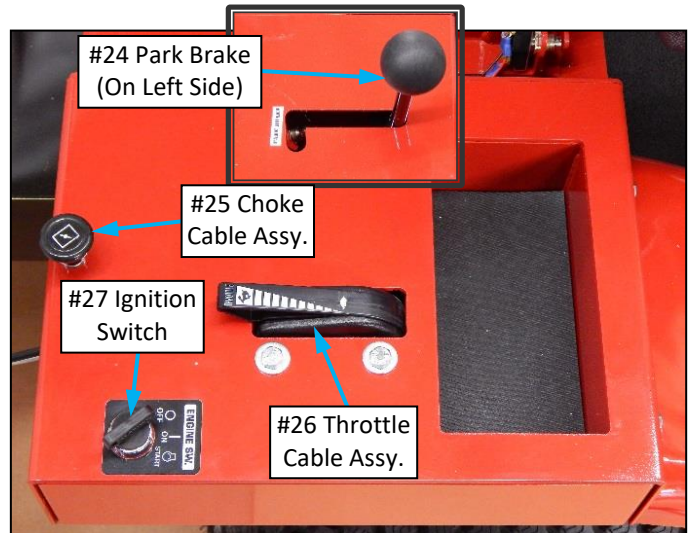
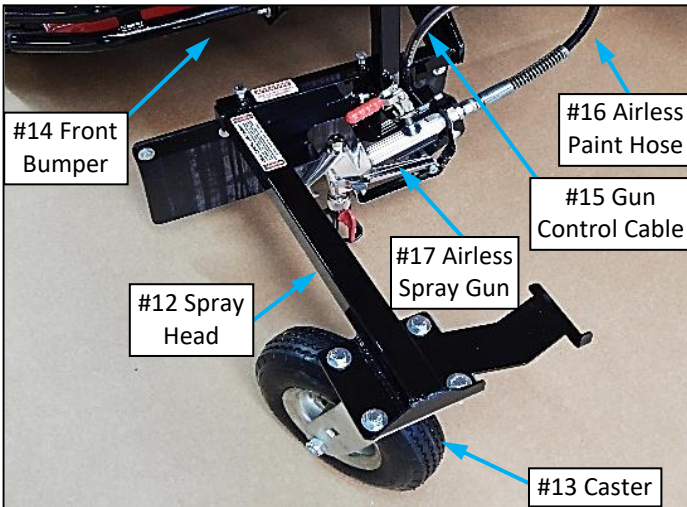
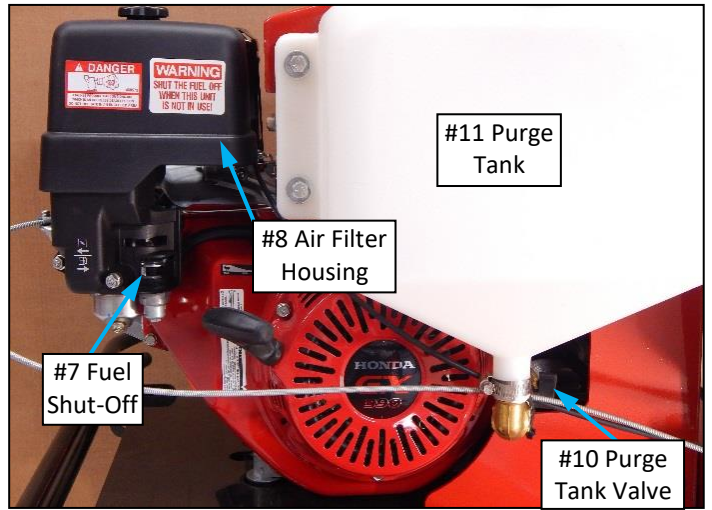
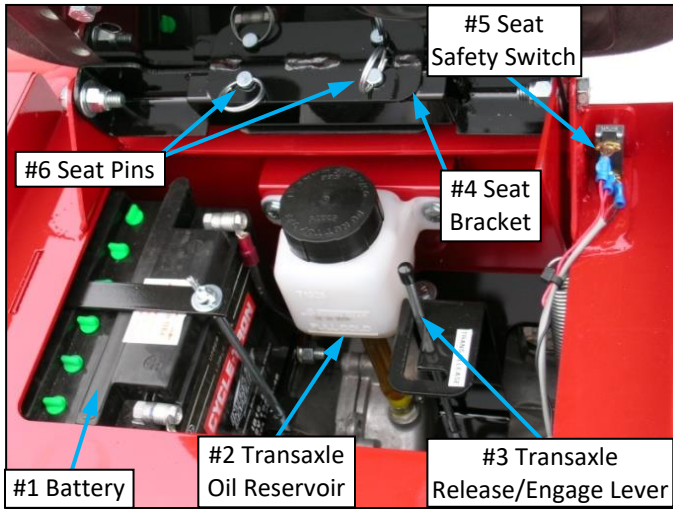

Brite Striper 7000 Airless Riding Field Line Striper

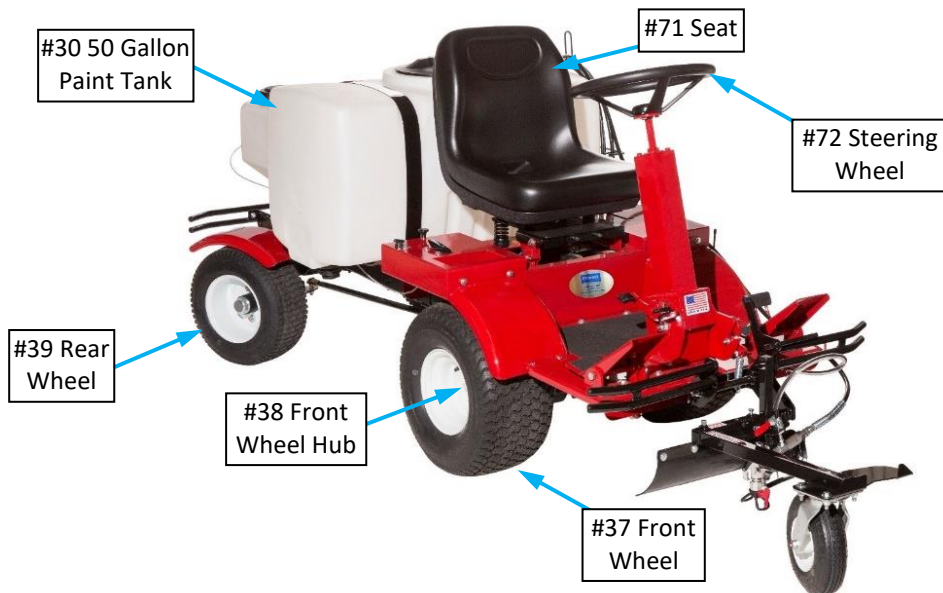
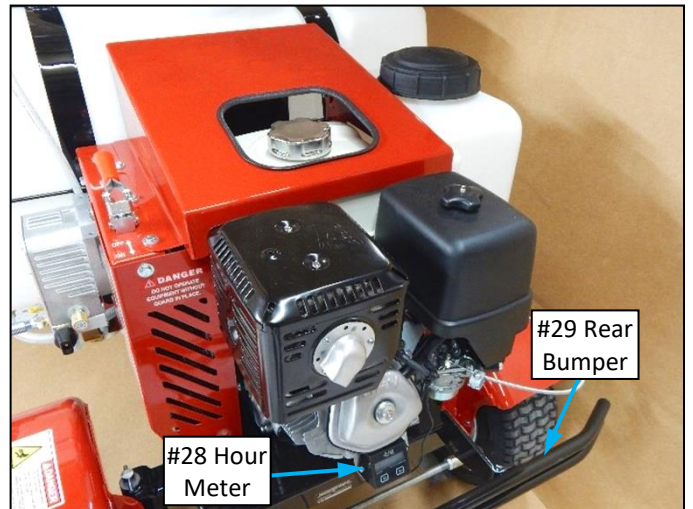
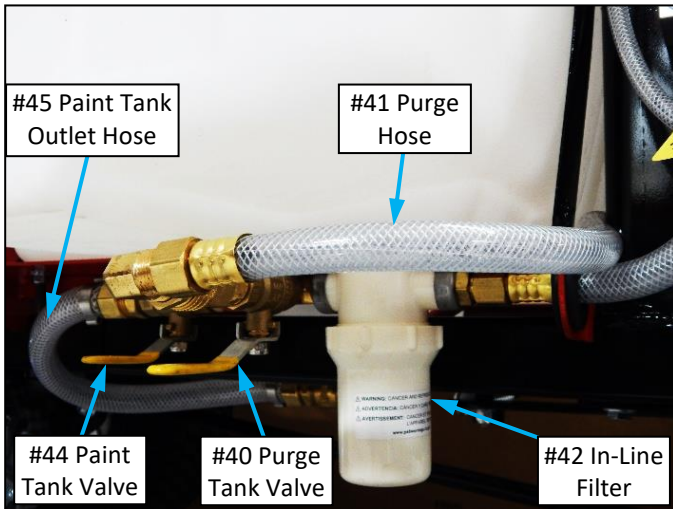
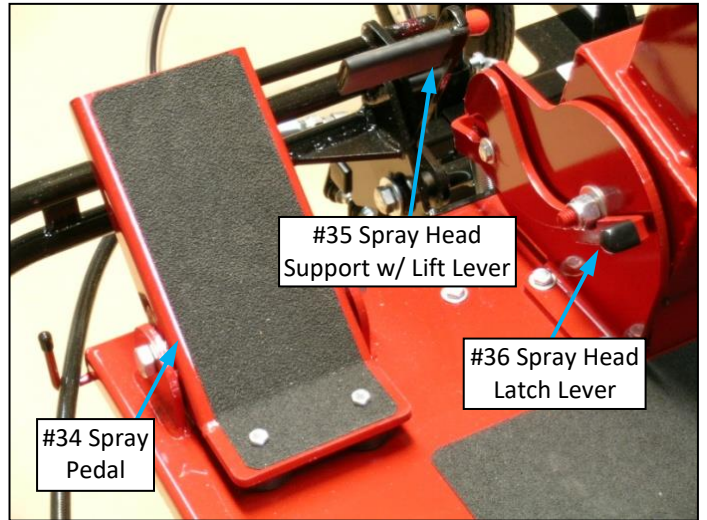
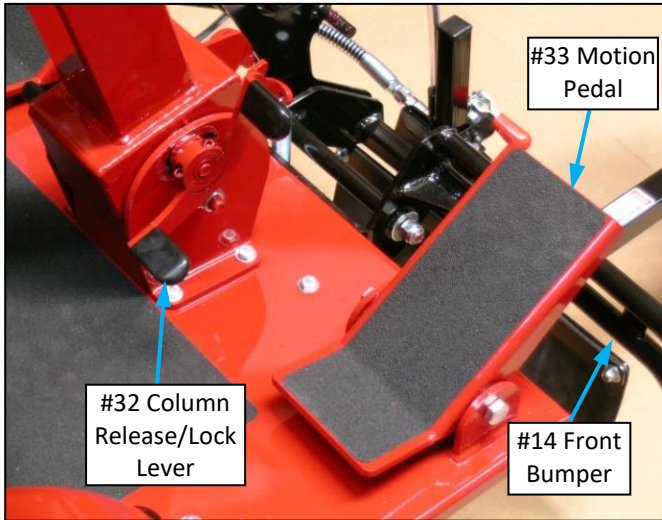

Brite Striper 7000 Airless Riding Field Line Striper

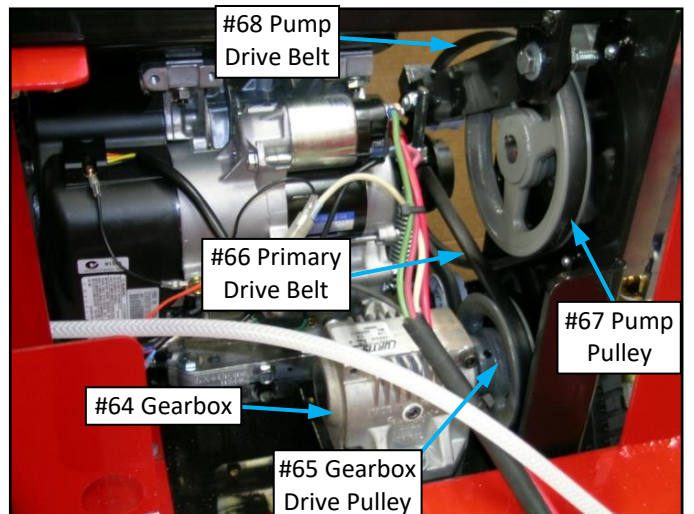
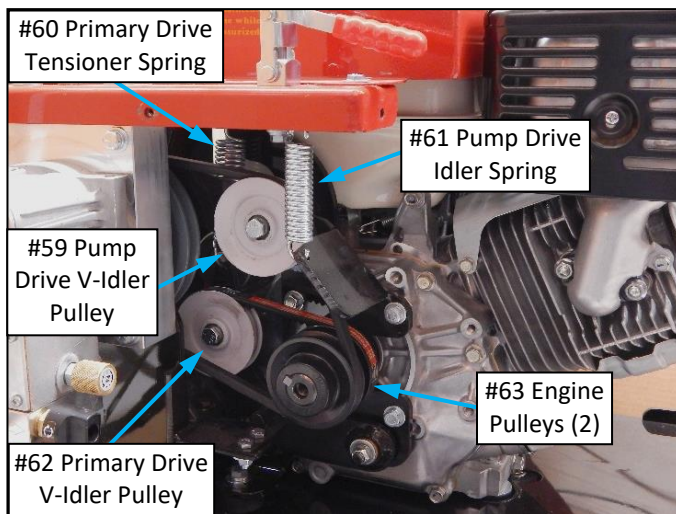
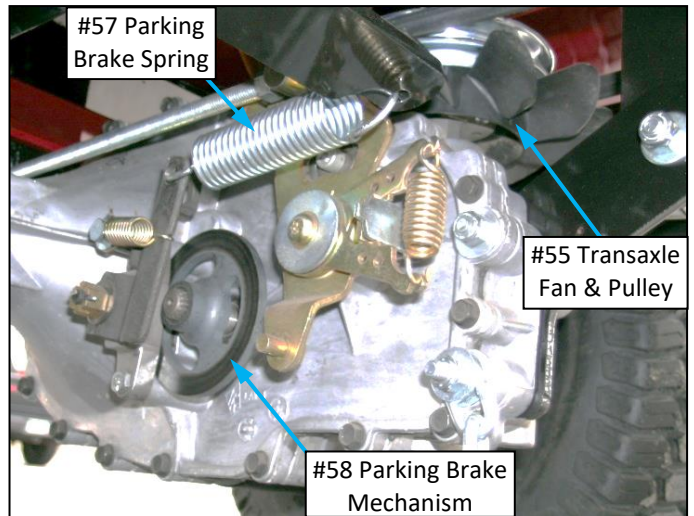
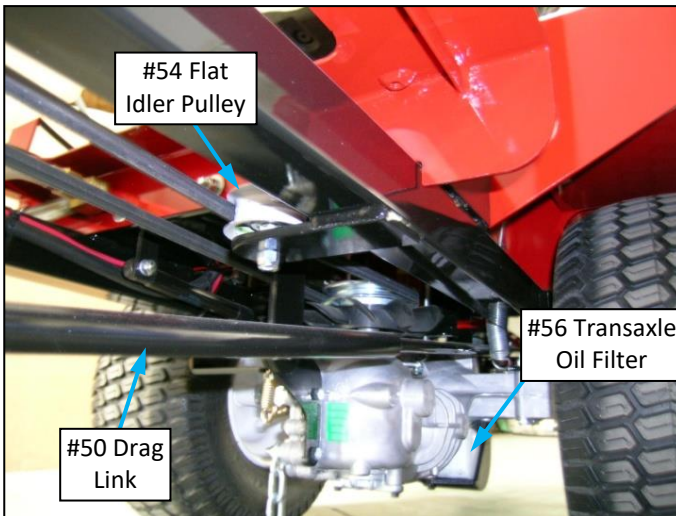
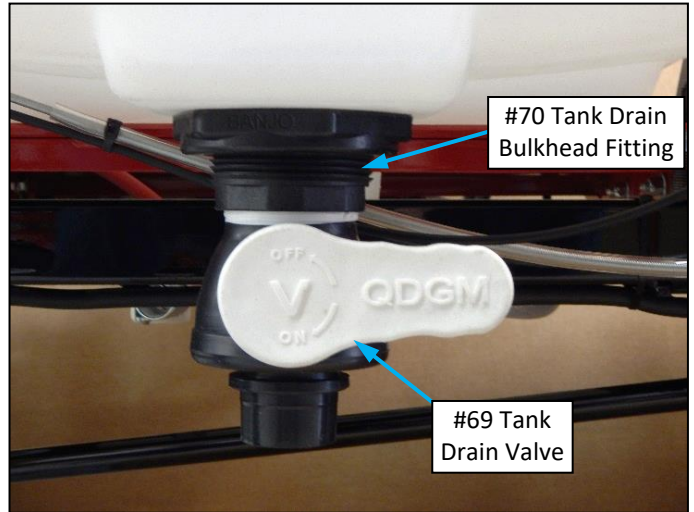
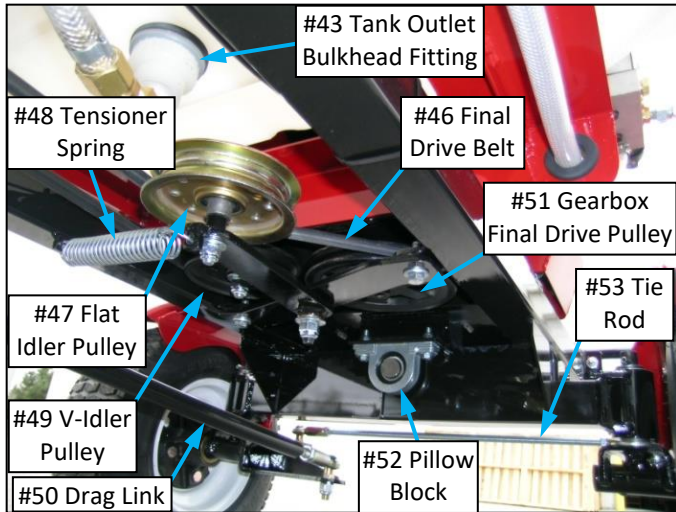

Brite Striper 7000 Airless Riding Field Line Striper

AIRLESS PUMP PARTS

Item Number	Description	Part Number
73	Bypass/Return Hose	10003235
74	Spray Pump	10005238
75	Pump Inlet Hose	10004117
76	Pressure Valve	N/A
77	Inlet Valve	10002745
78*	Outlet Push Button *Available in Outlet Valve & Push Button Kit ONLY	10005102
79*	Outlet Valve *Available in Outlet Valve & Push Button Kit ONLY	10005102
80	Prime Spray Valve	10004000
81	Pump Engaging Lever	10001817
82	0-5000 psi Gauge	10003883

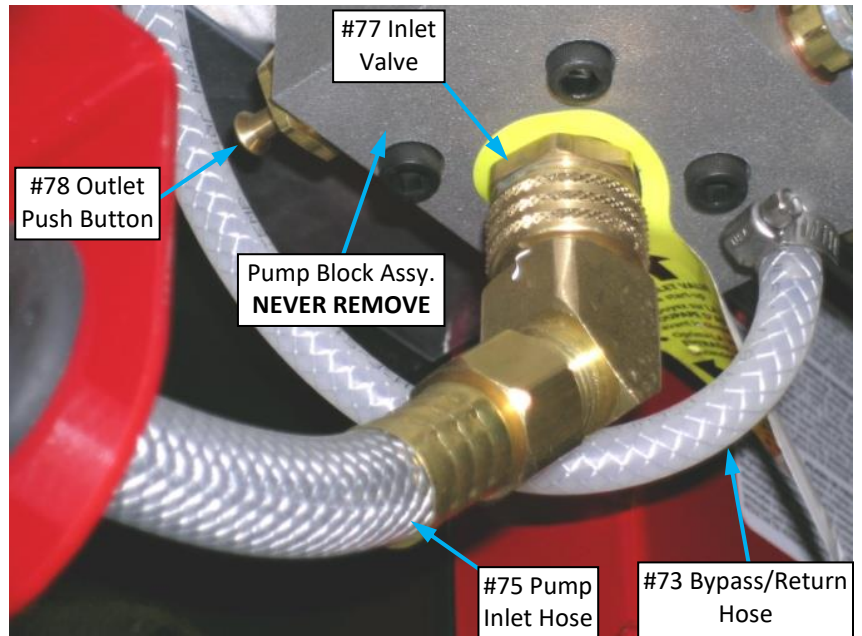
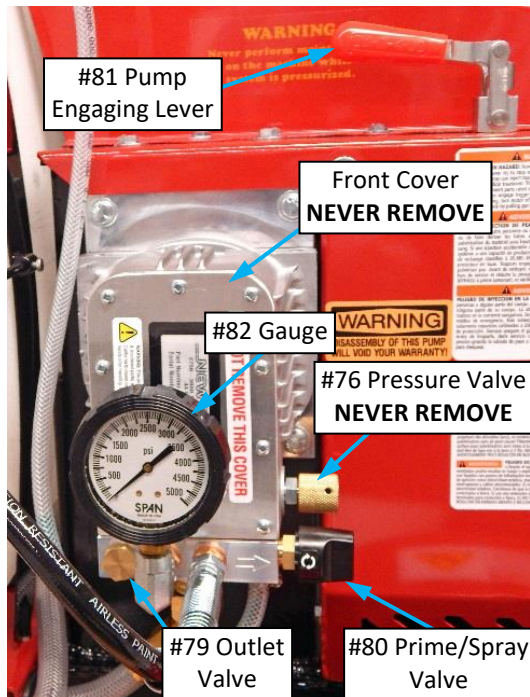

4529 Industrial Park Way, Cleveland, OH 44135 T 800.877-1500 • Pioneerathletics.com

Brite Striper 7000 Manual / 3033P.0524

Brite Striper 7000 Airless Riding Field Line Striper

AIRLESS SPRAY GUN DETAIL

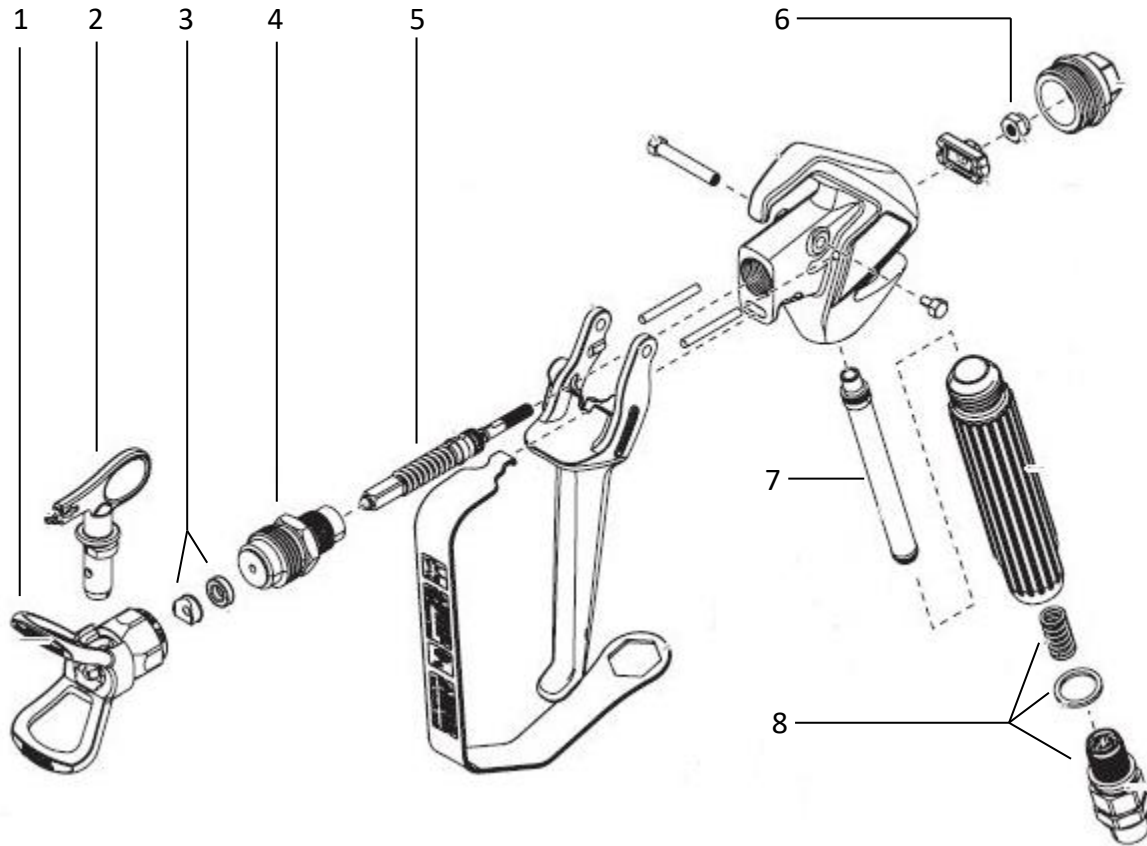

#	Part Number	Description
1	10005116	SPRAY TIP GUARD
2	10002103	319 SPRAY TIP - STANDARD FOR GPS AND SKID MOUNTED STRIPERS
	10005230	419 WHITE SPRAY TIP - UP TO 4" WIDE LINES
	10005151	619 WHITE SPRAY TIP - STANDARD TIP FOR RIDE ON STRIPERS
	10005232	621 WHITE SPRAY TIP - ALLOWS FOR HEAVIER PAINTED LINES
3	10005119	TIP SEAL KIT, PACKAGE OF 5
4	SEE # 9	7/8" DIFFUSER
5	SEE # 9	SEAL NEEDLE ASSEMBLY
6	SEE # 9	LOCK NUT
7	10000641	50 MESH GUN FILTER - STANDARD FILTER FOR STRIPERS
	10004384	OPTIONAL 30 MESH COARSE GUN FILTER
8	10005135	SWIVEL FITTING KIT
9	10005117	AIRLESS SPRAY GUN REPAIR (Includes Item Numbers 4, 5, and 6)



4529 Industrial Park Way, Cleveland, OH 44135 T 800.877-1500 • Pioneerathletics.com

Brite Striper 7000 Manual / 3033P.0524

Brite Striper 7000 Airless Riding Field Line Striper

TRANSAXLE SERVICE AND MAINTENANCE

Fluid & Filter change

This transaxle is designed with an external filter for ease of maintenance. To ensure constant fluid quality levels and longer life, an initial oil and filter change at 75-100 hours, then every 400 hours thereafter is recommended. The following procedure can be performed with the transaxle installed in the vehicle, and the vehicle on level ground. Apply the bypass valve and lock the vehicle parking brake.

1. Remove the three 1/4" filter guard screws and filter guard. Clean any loose debris from around the perimeter of the filter.
2. Place an oil drain pan (12" or more diameter and 8 qt. capacity is optimal) beneath the oil filter. Remove the oil filter from the transaxle.
3. After the oil has drained, wipe the filter base surface off and apply a film of new oil to the gasket of the new replacement filter (**Newstripe part number 10003778/Hydro-Gear part number 52114 ONLY**).
4. Install the new filter by hand, turn 3/4 to one full turn after the filter gasket contacts the filter base surface.
5. Re-install the filter guard with three 1/4" screws (Snug - Do not over tighten).
6. Drain old oil filters of all free flowing oil prior to disposal. Place used oil in appropriate containers and deliver to an approved recycling collection facility.
7. Remove the oil level check port plug from the transaxle prior to filling with oil. This will allow the transaxle to vent during oil fill.
9. Fill with **Mobil 1 Full Synthetic 15W50 Motor Oil ONLY** through the reservoir bottle under the seat until oil just appears at the bottom of the oil level check port. Install the oil level check port plug into transaxle. (Snug - Do not over tighten).
10. Top off the reservoir with **Mobil 1 Full Synthetic 15W50 Motor Oil ONLY** to the "FULL COLD" mark
11. Proceed to the purge procedure.
12. Top off the reservoir with **Mobil 1 Full Synthetic 15W50 Motor Oil ONLY** to the "FULL COLD" mark.

****Warning: Use ONLY Mobil 1 Full Synthetic 15W50 Motor Oil and Newstripe Filter Part Number 10003778 in the transaxle of this machine.**

Failure to use the correct filter and oil will cause damage to the transaxle and void the warranty

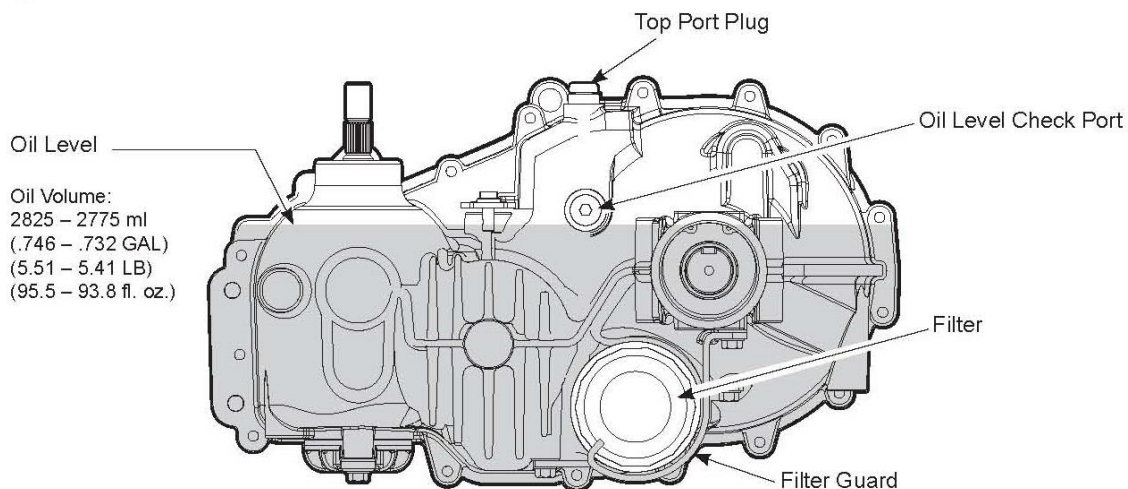

4529 Industrial Park Way, Cleveland, OH 44135 T 800.877-1500 • Pioneerathletics.com

Brite Striper 7000 Manual / 3033P.0524

Brite Striper 7000 Airless Riding Field Line Striper

TRANSAXLE SERVICE AND MAINTENANCE (CONTINUED)

External Maintenance

1. Check the oil level in the reservoir under the seat daily.
2. Inspect the vehicle drive belt, idler pulleys, and idler springs. Insure that no belt slippage can occur. Slippage can cause low input speed to the transaxle.
3. Inspect the vehicle control linkage to the directional control arm on the transaxle. Also ensure that the control arm is securely fastened to the trunnion arm of the transaxle.
4. Inspect the bypass mechanism on the transaxle and the vehicle linkage to insure that both actuate and release fully.

Purging

Due to the effects air has on efficiency in hydrostatic drive applications, it is critical that it is purged from the system.

Air creates inefficiency because its compression and expansion rate is higher than that of the oil approved for use in hydrostatic drive systems. These purge procedures should be implemented any time a hydrostatic system has been opened to facilitate maintenance or the oil has been changed. The resulting symptoms in hydrostatic systems may be:

1. Noisy operation.
2. Lack of power or drive after short term operation.
3. High operation temperature and excessive expansion of oil. Before starting, make sure the transaxle is at the proper oil level. If it is not, fill to the specifications outlined in this manual.

Purging Procedures

The following procedures are best performed with the vehicle drive wheels off the ground. Then repeated under normal operating conditions. If this is not possible, then the procedure should be performed in an open area free of any objects or bystanders.

1. Disengage the brake if activated.
2. With the bypass valve open (Transaxle release lever towards rear and over in slot) and the engine running, slowly move the directional control in both forward and reverse directions (5 or 6 times).
3. With the bypass valve closed (Transaxle release lever in forward position) and the engine running, slowly move the directional control in both forward and reverse directions (5 to 6 times). Check the oil level, and add oil as required after stopping the engine.
4. It may be necessary to repeat Steps 2 and 3 until all the air is completely purged from the system. When the transaxle operates at normal noise levels and moves smoothly forward and reverse at normal speeds, then the transaxle is considered purged.

Please call Pioneer Athletics if you have any questions regarding any of the above procedures.



4529 Industrial Park Way, Cleveland, OH 44135 T 800.877-1500 • Pioneerathletics.com

Brite Striper 7000 Manual / 3033P.0524

Brite Striper 7000 Airless Riding Field Line Striper

TROUBLESHOOTING GUIDE

PROBLEM	REMEDY
Oil flows out at dipstick when checking oil.	STOP! DO NOT START THE ENGINE. Call Pioneer immediately. The fuel lever was left in the on position and fuel has drained into the sump.
Engine will not turn over.	Check that the battery is connected and fully charged.
Engine turns over but will not start.	Check that there is fresh gasoline in the fuel tank and the fuel lever is on. Make sure throttle lever is in the full position, and the choke knob is pulled up. Check the oil level. The engine is equipped with an oil safety switch and will not start if the oil level is too low. The engine will also shut off if the oil level becomes too low.
Engine will still not start.	Call Pioneer for assistance.
Engine starts but runs rough.	Check that the choke is turned off (knob pushed down).
Choke off but the engine still runs rough.	Check for proper fuel. Check the spark plug for fouling. Clean or replace it if necessary. Check the air filter. Replace it if it is dirty.
Machine will not move when the pedal is pressed.	Check that the transaxle release lever under the seat is engaged. (forward position)
Machine will still not move.	Check that the hand brake is released. Note: If you changed the transaxle oil, you will need to purge the system. See the Transaxle Fluid Change Procedure.
Machine will still not move.	Call the Pioneer for assistance.
Pump will not prime. (No fluid returning to the tank)	Check that the pump engage lever is in the "On" position.
Lever engaged, but the pump will still not prime.	Check that the Prime/Spray Valve is in the prime position (circular arrows aligned with the arrow on the pump block).
The Prime/Spray Valve is in the prime position and the pump still will not prime.	Check that the pressure control valve is in the high pressure position. (pressure valve turned in fully clockwise just until it stops) Do not over tighten!
Valves are set correct, but the pump still will not prime.	Push the brass outlet button 3 times.
Outlet button pushed, but the pump still will not prime.	Turn the Prime/Spray valve to the prime position and turn the Pressure Control Valve knob out counterclockwise several turns until it feels loose. Let pump run for one minute and then turn the pressure valve knob all the way back in to the high pressure setting. Do not over tighten!
Valves are correct, button pushed, but the pump still will not prime. NOTE: A loose inlet fitting, worn or missing rubber washer on the inlet hose is the #1 reason for the pump failing to prime.	Remove the garden hose fitting from the inlet side (bottom) of the pump. Depress inlet valve stem inside the inlet valve with your finger so it moves freely. Reconnect the inlet hose. MAKE SURE that the inlet hose fitting is tight and that the rubber washer is present and in good condition. Note: You may need to lightly snug the inlet hose fitting with a pair of pliers. Restart the engine & prime as above.
Pump will still not prime.	Call the Pioneer for assistance.
Pump primes, but bubbles appear in the return hose after one minute.	Ensure that the inlet hose is tight. If the hose is tight and the rubber washer is present and in good condition, call Pioneer.



4529 Industrial Park Way, Cleveland, OH 44135 T 800.877-1500 • Pioneerathletics.com

Brite Striper 7000 Manual / 3033P.0524

Brite Striper 7000 Airless Riding Field Line Striper

TROUBLESHOOTING GUIDE (CONTINUED)

PROBLEM	REMEDY
Pump primes and is running, but the gun does not spray.	Check that the prime/spray valve is in the spray position. Check that the pressure control valve is in the high pressure position. (pressure valve turned in fully clockwise just until it stops) Do not over tighten!
Valves are set correctly, but the gun still does not spray.	Check that trigger lock on spray gun is pushed to the unlocked position. Check that the spray tip arrow is pointing towards ground. Check that the lifting bar is operating the gun trigger.
All of above are correct, but the gun will still not spray.	Turn the Prime/Spray Valve to the prime position, turn off the engine, and then trigger the gun to release pressure. Check spray gun filter in the gun handle and replace it if it is clogged. Restart.
Gun will still not spray paint.	Call Pioneer for assistance.
Over spray or too much paint.	Lower the spray pressure by turning the pressure control valve knob counter clockwise several turns, and then turn it clockwise to increase the spray pressure, just until spray pattern is full width.
Too little paint.	Increase the spray pressure. The paint may need to be thinned. Change spray tip to a larger size.
Uneven spray pattern or stringing.	Increase the spray pressure. The spray tip may be chipped or clogged. Reverse the tip and clean it.
Pressure is increased, tip is clean, but the spray is still not correct.	Worn tip. (sprayed more than 100 gallons) Replace the tip.
Replaced the spray tip, but the spray is still not correct.	Call Pioneer for assistance.

Your machine is designed to be simple and safe to operate.
Please call Pioneer at 1-800-877-1500 if you have any questions.



Brite Striper 7000 Airless Riding Field Line Striper

10003033P

36 Month Warranty

Pioneer Athletics ("Pioneer") warrants to the original purchaser, for 36 (Thirty Six) Months after date of purchase, that the equipment* hereby sold shall be free of defects in materials and workmanship. This warranty does not extend to any damage or malfunction resulting in misuse, neglect, accident, improper operation, or normal wear and tear.

* Gasoline engines, compressors, low pressure pumps, and transaxles are furnished with their respective manufacturers' warranties only and are not covered by any warranty of Pioneer. High pressure pumps manufactured by Pioneer (excluding wear items like diaphragms and valves) are warranted for materials and workmanship for 12 Months after the date of purchase.

Damage incurred in shipment from Pioneer to the purchaser is the total responsibility of the shipping carrier. The purchaser is responsible for noting any damages on the Bill of Lading of the shipping carrier and Pioneer will work with the shipping carrier to resolve any damages incurred.

The Pioneer obligation under this warranty and any implied warranties is limited to replacement or repair of defective parts of its manufacture without charge for 36 (Thirty Six) Months from date of purchase. For service under this warranty, the purchaser shall obtain an approved Return Materials Authorization (RMA) from Pioneer and then ship the defective part or parts of the equipment, transportation prepaid by the purchaser, to Pioneer together with a written description of any claimed defect and proof of purchase date of the materials being returned. To review Pioneer's complete guidelines for warranty claims and returns, please contact Pioneer Athletics.

The responsibilities described above are the only responsibilities of Pioneer under this written warranty or any implied warranty and may be exercised only within 36 (Thirty Six) Months from the date of original purchase. In no event shall Pioneer be liable for incidental or consequential damages and no person had any authority to bind it to any representation or warranty. Pioneer is not responsible for work done, materials furnished, or repairs made by others without its specific written authorization.

This warranty shall be in lieu of any and all other warranties, expressed or implied, including any warranties of merchantability or fitness for a particular purpose, and there is no other representation or warranty of any kind with respect to the goods sold hereby except as set forth herein. It is expressly agreed that this warranty shall be limited to the adjustment, repair or replacement of parts and the labor and services required thereby. In no event, including any claim of negligence, shall Pioneer be liable for incidental or consequential damages.



4529 Industrial Park Way, Cleveland, OH 44135 T 800.877-1500 • Pioneerathletics.com

Brite Striper 7000 Manual / 3033P.0524